

**Ansys**

# ADVANTAGE

EXCELLENCE IN ENGINEERING SIMULATION

ISSUE 1 / 2020

## *Win the Intelligent Mobility Race*



**24**

Underground  
Radar Mapping for  
Autonomous Vehicles

**27**

Powering the  
Internet of Things

**30**

Xilinx Simulates  
FPGA Scalability

# Bring it On

At Ansys, it is our mission to empower you to design and deliver transformational products through pervasive simulation. To do that, we stay on the forefront of innovation because your needs are constantly evolving. To solve the world's toughest challenges, we embrace change.

Over the last 50 years, change has been a constant at Ansys. We have built a track record of excellence, and in the process, developed the premium brand in our space. But we're not content to rest on our past accomplishments.

You may have noticed we are unveiling a new look with this issue of *Ansys Advantage*. The refreshed branding is being extended throughout Ansys as a whole. An updated logo and visual layout are just small parts of what makes a brand, but we hope ours inspires you as much as it inspires us to keep on engineering what's next.

The refresh reflects our shared purpose to rise to any challenge for our customers.

## TURN CHALLENGES INTO OPPORTUNITIES

At Ansys, we help customers like you overcome "can't" every day. There is a way. It can be done. We will find it. To every challenge, we say: "Bring it on." Our enthusiasm and optimism, coupled with tenacity and perseverance, means we meet every challenge with the expectation of success.

I am proud of the hard work and dedication from the Ansys



**Lynn Ledwith**, Vice President, Marketing, Ansys

teams who have helped to make this change happen and set us on our journey ahead.

I'd love your feedback about this issue of *Advantage* magazine, Ansys in general and our new look. You can email me at [brand@ansys.com](mailto:brand@ansys.com).

## Flexible **Solutions** for the Engineering World

- Optimized compute platforms for CAE workloads
- Remote graphics and batch scheduling enabled
- Maximize efficiency of available licenses
- Simplified integration within existing infrastructures
- Built with the latest Intel® Xeon® Processors

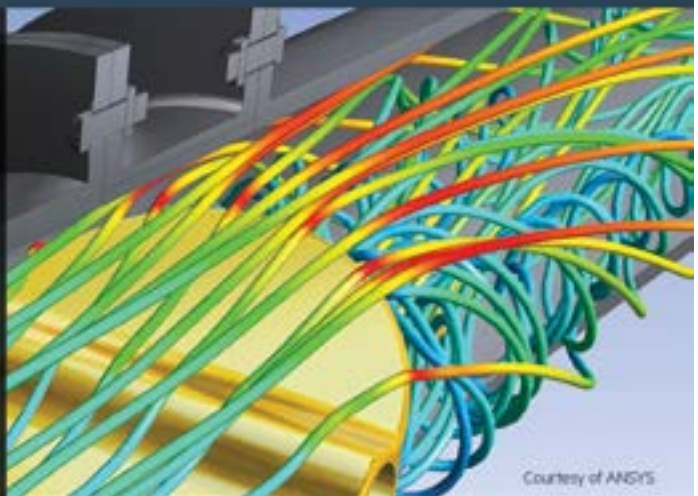

Courtesy of ANSYS

[www.hpe.com/info/hpc-manufacturing-and-engineering](http://www.hpe.com/info/hpc-manufacturing-and-engineering)

© Copyright 2020 Hewlett Packard Enterprise Development LP  
© Copyright 2020 Intel, the Intel logo is trademark or registered trademark of Intel Corporation in the U.S. and/or other countries

Hewlett Packard  
Enterprise



# Winning the Race to Mobility

We are at the beginning of a great mobility revolution that is set to transform the way we move ourselves and our goods. Autonomous vehicles are set to make our commutes safer and more productive. Electrification will make vehicles greener. Air taxis will make urban air mobility a reality and shrink hourlong commutes to minutes. Reliable 5G connectivity will enable vast transportation networks of robo-taxis and drones, bringing ubiquitous mobility to all.

The race is on among traditional vehicle manufacturers and disruptive mobility startups to be the first to bring viable autonomous, electric and shared vehicles to market. Automakers worldwide are expected to launch more than 300 new battery-electric vehicle models in the next four years.<sup>1</sup> Commercial Level-3 autonomous vehicles are set to go on sale as early as next year.<sup>2</sup>

It is an exciting time of change and steep challenges. Advanced driver assistance systems and autonomous vehicle makers must demonstrate that their automated driving systems can operate safely in myriad potential driving scenarios and are cybersecure. Electric vehicles must overcome the grand challenges of reducing cost, range anxiety and long charging times. At the same time, the industry must deliver an enhanced, connected customer experience with seamless mobile connectivity that meets ever-more stringent cost, quality, safety and efficiency requirements.

## TAKING THE LEAD

The mobility revolution is an existential disruption for the transportation industry. Companies that innovate fast amid uncertainties will emerge

as leaders in the mobility industry. Engineering simulation is an innovation accelerator that is key to success in rapidly developing, transformational products like autonomous and electric vehicles.

Ansys delivers technology, processes and people to help businesses rapidly deploy simulation at scale for these new applications. Ansys' multiphysics, multidisciplinary simulation platform provides comprehensive solutions for vehicles that can be deployed at scale using high-performance computing and the cloud coupled with data management. Ansys' platform is open and connects with a wide partner ecosystem to seamlessly deliver custom workflows needed by clients. Ansys' transformational team of solution architects and domain experts delivers technology transfer services, best practices, training and support to help customers rapidly ramp up simulation deployments.

This issue of *Ansys Advantage* showcases the achievements of several technology companies from around the world that are making outstanding contributions to the ongoing mobility revolution by using Ansys software to rapidly develop groundbreaking technologies.



**Sandeep Sovani,**  
Ph.D., Global Director –  
Automotive Industry, Ansys

- Edge Case Research's perception robustness testing software is integrated into Ansys SCAD Vision to improve the safety of autonomous vehicles.
- WaveSense is using [Ansys HFSS](#) to develop a system to map the underground features of roads for more precise location verification.
- With the help of Ansys HFSS simulation, radar and 5G startup Metawave is building a breakthrough radar platform.
- Teratonix uses Ansys HFSS to develop an antenna and Ansys Electronics Desktop in the design of its impedance-matched rectifier.

For those not involved in mobility, fear not. This issue also shows how Ansys customers are implementing simulation to solve tough problems in industries as varied as chip design, nuclear energy and more.

By helping our customers develop innovative technologies, Ansys is making the world a greener, safer and more connected place for generations to come. **▲**

1. [mckinsey.com/industries/automotive-and-assembly/our-insights/the-future-of-mobility-is-at-our-doorstep](https://www.mckinsey.com/industries/automotive-and-assembly/our-insights/the-future-of-mobility-is-at-our-doorstep)

2. [bmwblog.com/2018/09/01/autonomous-driving-bmw-group-focuses-on-level-3-and-4](https://www.bmwblog.com/2018/09/01/autonomous-driving-bmw-group-focuses-on-level-3-and-4)

# Table of Contents



## Focus on Intelligent Mobility

12

FOCUS: AUTONOMY

### AUTONOMOUS CARS TO RACE AT INDIANAPOLIS MOTOR SPEEDWAY

The Indy Autonomous Challenge is a competition among universities to create software that enables self-driving race cars to compete in head-to-head races — one simulated and one at the real world Indianapolis Motor Speedway.

15

FOCUS: ARTIFICIAL INTELLIGENCE

### AUTONOMOUS SAFETY IN SIGHT

Discover how Ansys SCADE Vision powered by Hologram automates the identification of perception detection defects known as edge cases to advance autonomous vehicles.

20

FOCUS: ELECTROMAGNETICS

### TAKE SIMULATION UNDERGROUND

Take a peek at how WaveSense engineers are using Ansys HFSS electromagnetic solutions to develop a system to map the underground features of roads for precise location verification in all conditions.

24

FOCUS: BEAMSTEERING

### A NEW KIND OF EYES ON THE ROAD

See how simulation, radar and 5G startup Metawave has built a breakthrough autonomous vehicle radar platform to overcome the traditional challenges of long distances, inclement weather and more with the help of Ansys HFSS.

## DEPARTMENTS

1

EDITORIAL

### Winning the Race to Mobility

4

BEST PRACTICES

### Engineer Perception, Prediction and Planning into ADAS

10

SURVEY STATS

### When Will Self-Driving Cars Outperform Humans?

52

INNOVATION SHOWCASE

### Ansys Hall of Fame Winners

54

ANALYSIS

### Simulation in the News

**27**

**ANTENNA DESIGN**

**OUT OF THIN AIR**

Using Ansys HFSS and Ansys Electronics Desktop, Teratonix designed a radio frequency harvester that can collect ambient RF signals and convert them to electricity.

**30**

**CHIP DESIGN**

**PHYSICAL VERIFICATION COMPLEXITY**

Xilinx engineers wanted to leverage big-data analytics to simplify their verification flow on leading-edge chips, and they looked to Ansys for answers.

**36**

**THERMAL EXCHANGE**

**RAPIDLY MEET HEAT EXCHANGER REGULATIONS**

See how Grantec Engineering used Ansys Mechanical

software to perform finite element analysis-based strength assessments for a range of condenser and evaporator heat exchangers to gain rapid approval from regulatory authorities.

**40**

**THERMAL EXCHANGE**

**SAVINGS BOIL OVER WITH SIMULATION**

Ferrolti, a manufacturer of boilers and renewable energy products, used Ansys Fluent to respond to market requirements for a high-efficiency heat exchanger. Learn how the results enabled them to create an optimized design for a robust, high-performance condensing heat generator.

**44**

**THERMAL EXCHANGE**

**SIMULATING A SALT-COOLED REACTOR FOR SAFETY**

To improve upon existing technology, Kairos Power uses Ansys Fluent and Ansys Mechanical to develop a heat transport system for a low-pressure, high-temperature nuclear power reactor.

**48**

**CLOUD COMPUTING**

**FAST FLUID SIMULATION ON THE CLOUD**

To perform analyses rapidly and affordably, Toyo Advanced Technologies engineers used Ansys Fluent via a cloud service for model-based CAE, instead of installing a high-performance computing system in their own facility.

**W**elcome to *Ansys Advantage*! We hope you enjoy this issue containing articles by Ansys customers, staff and partners.

**The Editorial Staff, Ansys Advantage**

**Executive & Managing Editor**

Jamie J. Gooch

**Editorial Advisers**

Lynn Ledwith, Mary Beth Clay, Rachel Wilkin, Sandeep Sovani

**Editorial Contributor**

Ansys Customer Excellence  
North America

**Editors**

Erik Ferguson, Kara Gremillion,  
Beth Harlen, Scott Nyberg  
Mark Ravenstahl, Walter Scott, Terri Sota

**Art Director**

Ron Santillo

**ANSYS, Inc.**, Southpointe,  
2600 Ansys Drive, Canonsburg, PA 15317

**Subscribe at** [ansys.com/subscribe](https://ansys.com/subscribe)

**Senior Editor**

Tim Palucka

**Designer**

Dan Hart Design

**Realize Your Product Promise®**

If you've ever seen a rocket launch, flown on an airplane, driven a car, used a computer, touched a mobile device, crossed a bridge, or put on wearable technology, chances are you've used a product where Ansys software played a critical role in its creation.

Ansys is the global leader in engineering simulation. We help the world's most innovative companies deliver radically better products to their customers. By offering the best and broadest portfolio of engineering simulation software, we help them solve the most complex design challenges and engineer products limited only by imagination.

Neither ANSYS, Inc. nor Dan Hart Design guarantees or warrants accuracy or completeness of the material contained in this publication.

ACT, Additive Print, Additive Science, Additive Suite, AIM, Aqwa, Autodyn, BladeModeler, CFD, CFD Enterprise, CFD Flo, CFD Premium, CFX, Chemkin-Pro, Cloud Gateway, Customization Suite, DesignerRF, DesignerSI, DesignModeler, DesignSpace, DesignXplorer, Discovery Live, EKM, Electronics Desktop, Elastic Licensing, Enterprise Cloud, Engineering Knowledge Manager, EnSight, Explicit STR, Fatigue, FENSAP-ICE, FENSAP-ICE-TURBO, Fluent, Forte, Full-Wave SPICE, HFSS, High Performance Computing, HPC, HPC Parametric Pack, Icepak, Maxwell, Mechanical, Mechanical Enterprise, Mechanical Premium, Mechanical Pro, Meshing, Multiphysics, Nexxim, Optimetrics, OptiSlang, ParICs, PathFinder, Path FX, Pervasive Engineering Simulation, PExprt, Polyflow, PowerArtist, Q3D Extractor, RedHawk, RedHawk-SC, RedHawk-CTA, Rigid Body Dynamics, RMXprt, SCADE Architect, SCADE Display, SCADE LifeCycle, SCADE Suite, SCADE Test, SeaHawk, SeaScape, SIwave, Simplorer, Solver on Demand, SpaceClaim, SpaceClaim Direct Modeler, Structural, TGrid, Totem, TPA, TurboGrid, Twin Builder, Workbench, Vista TF, Realize Your Product Promise, Sentinel, Simulation-Driven Product Development

ICEM CFD is a trademark licensed by ANSYS, Inc. LS-DYNA is a registered trademark of Livermore Software Technology Corporation. nCode DesignLife is a trademark of HBM nCode. All other brand, product, service, and feature names or trademarks are the property of their respective owners.

# Engineer Perception, Prediction and Planning into ADAS

**Hardware, software and humans need to be in the loop to advance safe autonomous driving technologies.**

By **Gilles Gallee**, Autonomous Vehicle Business Developer, Ansys, La Farlede, France

Advanced driver assistance systems (ADAS) — such as forward collision warning (FCW), automatic emergency braking (AEB), lane departure warning (LDW), lane keeping assistance (LKA) and blind spot monitoring (BSM) systems — are estimated to have the potential to prevent more than a third of all passenger-vehicle crashes.<sup>1</sup> According to a AAA Foundation for Traffic Safety report<sup>2</sup>, such a reduction would in turn prevent 37% of injuries and 29% of deaths in crashes that involve passenger vehicles. To fulfill the potential of ADAS, as well as the even greater potential safety and convenience benefits associated with fully autonomous driving, simulation is needed to ensure that vehicles can perceive the world around them, predict what might happen next and plan accordingly.

There are a lot of literal and figurative miles between the current state of ADAS and Level 5 fully autonomous vehicles. Simulation is critical to getting there. An oft-cited report from Rand Corp. makes the case that autonomous vehicles would have to be driven hundreds of millions of miles and sometimes hundreds of billions of miles to demonstrate their reliability in terms of fatalities and injuries. For example, according to Rand<sup>3</sup>, to prove that autonomous vehicles would get into fewer serious crashes than human drivers would require a fleet of 100 autonomous cars traveling at 25 mph non-stop for 125 million miles — the equivalent of six years of driving. To provide the same evidence for fatal crashes, that same fleet would have to travel 8.8 billion miles, which would take about 400 years.

Currently, most ADAS functions fall in the Level 1 or 2 range. Even achieving Level 3 autonomy, in which a vehicle can take full control when certain operating conditions are met, is a challenging technological leap. It requires a combination of physical testing and simulation that includes hardware, software and humans in the loop. Each aspect of the autonomous vehicle technology stack is critical and requires people with different skills and knowledge to be involved.

## LEVELS OF AUTONOMY

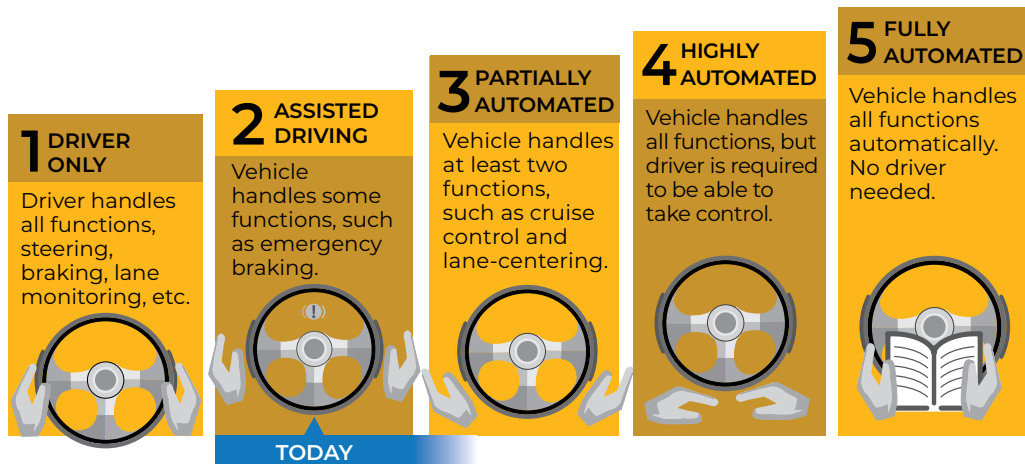

SAE International, the Society of Automotive Engineers, first published J3016 autonomy level guidelines in 2014. They have since been adopted by both the U.S. Department of Transportation and the United Nations.

### SOLVE THE PERCEPTION AND PLANNING PROBLEMS WITH SENSORS AND AI

Sensors are the eyes and ears of ADAS. Like our own senses, weather and complicated driving conditions can confuse and overwhelm them. In the automotive industry, suppliers have been challenged to develop sensors and sensing systems that function at a higher level so that they not only perform well on sunny days in light freeway traffic, but in blizzards, on busy city streets and under a multitude of “edge cases.” Edge cases encompass those unusual scenarios that don’t happen often, but often lead to accidents — a dog chasing the car in front of you, construction workers rerouting traffic, or a flash flood making a roadway impassable are just a few of many edge cases.

ANSYS SCADE Vision powered by Hologram helps to identify the edge cases to pinpoint the weakness of AI. Armed with edge case information, SCADE Vision can then trigger more AI training actions and new testing scenario conditions. See page 15 for more information about Ansys SCADE Vision.

Software developers are interested in generating synthetic data from simulation to more quickly train AI in various operation design domains (ODD),



**Fast Tracking ADAS Autonomous Vehicle Development with Simulation webinar**  
[Ansys.com/fasttrack](https://www.ansys.com/fasttrack)

the term used to describe subsets of driving conditions with particular environmental, geographical, time-of-day, traffic and/or roadway characteristics. Defining and identifying ODDs are challenges for developers because they affect testing, compliance and real-world Level 3 autonomous driving. For a car to take over from a human driver under certain conditions, the sensors must perceive those conditions and the software must interpret those perceptions to determine whether ODD requirements have been met. Simulation helps developers explore those ODD edge cases.

Original equipment manufacturers (OEMs) rely on their supplier tiers to provide sensor sets. However, OEMs are ultimately responsible for the safety of the cars they produce, so they want to be sure suppliers have fully vetted those technologies. Suppliers are using simulation at the component and packaging levels to better understand the strengths and weaknesses of various sensing technologies, such as [Ansys SPEOS](#) for lidar and cameras and [Ansys HFSS](#) for radar (see pages 20 and 24). The goals are to improve individual sensing technologies and ensure the various technologies can be used together to help create a robust sensor array that can handle whatever edge cases come up.

The [Ansys VRXPERIENCE Driving Simulator powered by SCANeR](#) forms the basis of an ADAS development cycle. It provides ADAS development teams with the capability to recreate driving scenarios and enables testing against a variety of objectives and performance requirements. By replicating roads generated from high-definition maps and asset libraries, traffic situations, weather conditions, vehicle dynamics and more, ADAS development teams can validate sensor and AI modules, sensor systems and vehicle models, as well as human-machine interfaces (HMIs).

### SIMULATE ADAS FUNCTIONS

ADAS functions are driven by software development. Custom vehicle models can be connected to Ansys VRXPERIENCE through FMI, C/C++, [Ansys Twin Builder](#) or MathWorks Simulink. Engineers can put vehicles in an environment with certain conditions — for example, on a highway arriving at a traffic jam at a certain speed — and quickly modify them for the scenarios and validation they'd like to perform. Based on that, they can simulate the scenario with different levels and types of sensors to assess sensor perception, sensor fusion and systems operations.

VRXPERIENCE can speed edge case exploration and sensor simulation. Take, for example, headlamp development. There are a lot of missed detection edge cases at night, so Ansys VRXPERIENCE has specific modules to simulate the physics of light. Intelligent lighting to automate when highbeams should turn on and off or automatically adjust to minimize glare may seem like simple conveniences, but lighting is an important piece of ADAS because the car's camera sensors react to it. Cameras that identify signs, road

## AUTOMATED PREVENTION

ADAS Systems	Crashes	Injuries	Deaths
Forward Collision Warning/Automatic Emergency Braking	1,994,000	884,000	4,738
Lane Departure Warning/ Lane Keeping Assist	519,000	187,000	4,654
Blind Spot Warning	318,000	89,000	274
Total Potentially Preventable by All Systems	2,748,000	1,128,000	9,496

**AAA Foundation research evaluated the potential that popular advanced driver assistance technologies have in helping to reduce or prevent crashes. The findings, which used U.S. data, show that if installed on all vehicles, ADAS technologies can potentially prevent more than 2.7 million crashes, 1.1 million injuries and nearly 9,500 deaths each year.**



lanes and oncoming vehicles are sensitive to headlamp design changes, for example. VRXPERIENCE reduces the time and cost of development by enabling a repeatable process for modified sensor inputs, such as lighting changes.

Another example is an emergency braking function that is part of an ADAS. To develop it, the function is first described as a model, often in MathWorks Simulink or Ansys SCADE Suite. It is tested to meet objectives and then designed as a more detailed model. The coding of the emergency braking function can then be tested vs. scenarios with software-in-the-loop and hardware-in-the-loop.



The Ansys VRXPERIENCE Driving Simulator powered by SCANeR is the basis for ADAS and the continuum all along the ADAS development cycle.

With Ansys VRXPERIENCE Driving Simulator powered by SCANeR, customers have a seamless process to test the model, connect it with SCANeR and then keep the same vehicle test environment to connect software and hardware as they simulate different ODD edge cases. The streamlined workflow saves time and makes it easier for geographically dispersed teams and experts from different disciplines to collaborate.

### PLANNING FOR HUMANS IN THE LOOP

In addition to predicting what other motorists, cyclists and pedestrians will do, ADAS also needs to account for how people will behave inside their cars. According to University of Iowa research<sup>4</sup>, people's behavior can change based on ADAS features. About 25% of the drivers surveyed who used blind spot monitoring or rear cross traffic alert systems reported feeling comfortable relying solely on the systems and not performing visual checks or looking over their shoulder for oncoming traffic or pedestrians. About 25% of vehicle owners using forward collision warning or lane departure warning systems also reported feeling comfortable engaging in other tasks while driving.<sup>5</sup>

Early adopters of ADAS technology proved that false positives or annoying alert sounds could cause them to ignore or disable safety features. As ADAS continues to take on a more prominent safety role, human-machine interaction becomes increasingly important. Here again, simulation can help automakers and suppliers implement ADAS by planning for how safety features will be used or misused.

Ansys VRXPERIENCE Driving Simulator powered by SCANeR integrates with driver hardware simulator interfaces to create an immersive driving experience with virtual reality. The [Ansys VRXPERIENCE HMI module](#) can be used to test and validate the full cockpit design for HMIs, including virtual displays and actuators, through visual simulation, eye and finger tracking, and haptic feedback. The virtual test driver can interact directly with the virtual interfaces, from touchscreens to switches, thanks to a fine finger tracking system. As the system records the behavior of the driver and displays driving and infotainment information, it identifies and interprets the actions of the driver and triggers the adapted HMI reaction automatically.



**Ansys VRXPERIENCE Driving Simulator powered by SCANeR automates scenario variability creation for massive simulation.**

***Advanced driver assistance systems have the potential to prevent more than a third of all passenger-vehicle crashes. Such a reduction would prevent 37% of injuries and 29% of deaths in crashes that involve passenger vehicles.***

ADAS developers can easily evaluate the relevance of the displayed information, in real time, for a safer drive. Ansys VRXPERIENCE reduces the time and cost of design because the evaluation of the design is mostly performed on virtual prototypes, reducing the number of expensive physical mock-ups necessary to create the product.

#### **CREATE A DISTINCT EXPERIENCE**

Safety is paramount, but HMIs are also a way for OEMs to differentiate themselves in the market. Much like the sound of an engine or the feel of a car door closing, the way people and automation interact has become a means to build a brand.

Ansys VRXPERIENCE allows OEMs and suppliers to evaluate different driver and passenger experiences as part of the same overall development process. Beyond ADAS, Ansys VRXPERIENCE also allows users to visualize the impact of assembly and shape deviations on the perceived quality of a product, considering manufacturing variations. Engineers can see and present the influence on perceived quality based on design and manufacturing data such as materials, fasteners and tolerances. They can simulate complex deformation effects such as arching, bending and distorting to identify the root cause of problem areas.

The [Ansys VRXPERIENCE SOUND module](#) provides an intuitive graphic display of sounds and a one-click magnification control feature to help create a sound signature. Users can also set up psychoacoustic tests based on a listener panel to obtain statistics about the real perception of sounds. Sound perception can be evaluated using tools based on time–frequency representations.

## COLLABORATE TO COMBINE TECHNOLOGICAL AND CULTURAL SHIFTS

As with any innovation that has the potential to disrupt the status quo, technology is only part of the story with ADAS. How that technology is used ultimately determines its success or failure in the market. All aspects of autonomous systems — the sensors that perceive the environment, the AI that interprets the sensor data and plans for how humans will interact with automation — must be considered.

The Ansys VRXPERIENCE Driving Simulator powered by SCANeR brings it all together in a workflow that encourages the collaboration necessary to vet new technology and how drivers and passengers will react to that technology.

The development of autonomous vehicles is one of the greatest engineering challenges of our day. It's a long road ahead, with significant milestones along the way. To meet the challenge, startups and established players are using simulation to get from here to there safely and efficiently. ▲

---

### Sources

1. "A Long Road to Safety," RAND Review, July-August, 2016.
2. "Potential Reduction in Crashes, Injuries and Deaths from Large-Scale Deployment of Advanced Driver Assistance Systems" A. Benson, B. C. Teft, A.M. Svancara and W. J. Horrey. AAA Foundation for Traffic Safety, 2018.
3. "Driving to Safety. How Many Miles of Driving Would It Take to Demonstrate Autonomous Vehicle Reliability?" Nidhi Kalra and Susan M. Paddock. Rand Corp., 2016.
4. "Vehicle Owners' Experiences with and Reactions to Advanced Driver Assistance Systems" A. McDonald, C. Carney and D. V. McGehee. University of Iowa, 2018.
5. "Understanding the Impact of Technology: Do Advanced Driver Assistance and Semi-Automated Vehicle Systems Lead to Improper Driving Behavior?" N. Dunn, T. A. Dingus and S. Soccolich. AAA Foundation for Traffic Safety, 2019.

**COMING SOON**

**The new Ansys Dimensions magazine!**

**SUBSCRIBE**  
[ansys.com/  
subscribeDimensions](https://ansys.com/subscribeDimensions)

SCAN ME

- / Focus on Executive-Level Strategy
- / Simulation for Digital Transformation
- / Thought Leadership
- / Disruptive Technologies
- / Bridge the Engineering-Executive Gap

# When Will Self-Driving Cars Outperform Humans?

The Ansys Global Autonomous Vehicles Report uncovers varying consumer attitudes regarding autonomous vehicles (AVs). Ansys commissioned the survey to gauge global consumer perception of AVs and better understand expectations for the future of travel. The report confirms consumers have high expectations for autonomous capabilities and are comfortable with the idea of riding in autonomous vehicles in their lifetime.

## COMPARING DRIVING ABILITIES

Seventy-one percent of consumers believe that autonomous cars are better drivers than humans or will surpass human abilities by 2029.

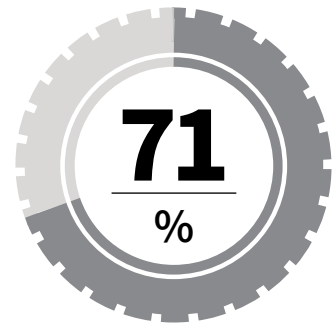

## COMFORT WITH AUTONOMOUS VEHICLES

Ninety-seven percent of Chinese respondents indicated they would be most comfortable riding in autonomous cars and aircraft during their lifetime, followed by those surveyed in India, Japan and the United States. In the United Kingdom, just 57% and 46% felt similarly.



US



UK



Japan



China



India

Comfortable riding in autonomous cars

69%

57%

80%

97%

94%

Comfortable riding in autonomous airplanes

61%

46%

75%

97%

90%



To view the report and learn more about the survey, visit [ansys.com/av-report](https://ansys.com/av-report).

## CONSUMER CONCERNS

When asked to select their greatest concern for riding in an autonomous car, 59% were most concerned with technological failure. A similar number (65%) showed the same trepidation about autonomous aircraft.

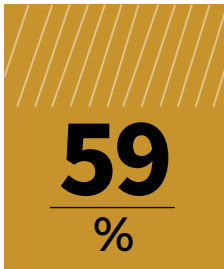

ARE MOST CONCERNED ABOUT AUTONOMOUS CAR TECHNOLOGICAL FAILURE

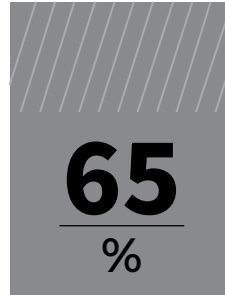

ARE MOST CONCERNED ABOUT AUTONOMOUS AIRCRAFT TECHNOLOGICAL FAILURE

## MILLENNIALS MATTER

Younger respondents were more interested in autonomous cars than older generations. Eighty-seven percent of 18- to 24-year-olds and 88% of 25- to 34-year-olds said they expect to ride in autonomous cars during their lifetime. Only 62% of 55- to 64-year-olds and 57% of those over 65 shared this sentiment.

Age group	18-24	25-34	35-44	45-54	55-64	65 and above
Expect to ride in autonomous cars during their lifetime	87%	88%	83%	73%	62%	57%

## TIMELINE FOR GLOBAL ADOPTION

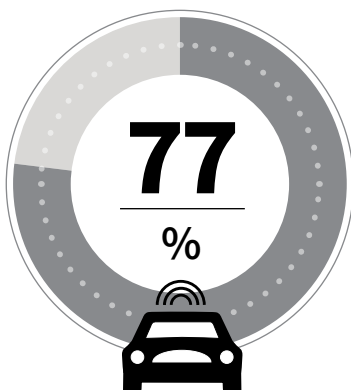

ARE READY TO RIDE IN AN AUTONOMOUS AUTOMOBILE IN THEIR LIFETIME

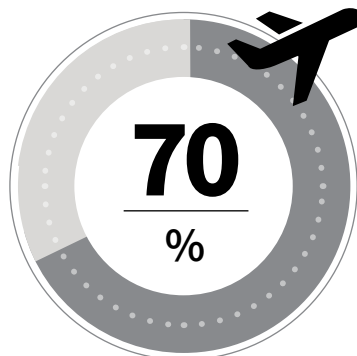

ARE READY TO RIDE IN AN AUTONOMOUS AIRCRAFT IN THEIR LIFETIME



# Autonomous Cars to Race at Indianapolis Motor Speedway

By Ansys Advantage Staff

A rendering of the autonomous version of Dallara's 210 mph IL-15 race car. *Images courtesy of Dallara.*

**A**nsys is the exclusive simulation sponsor of a two-year, \$1 million prize competition that will culminate in a head-to-head, high-speed autonomous vehicle (AV) race on Oct. 23, 2021, around the Indianapolis Motor Speedway's famed 2.5-mile oval, which also plays host annually to the Indianapolis 500 presented by Gainbridge, the largest single-day sporting event in the world.

The Indy Autonomous Challenge, organized by the Indianapolis Motor Speedway (IMS) and Energy Systems Network (ESN), is a competition among universities to create software that enables self-driving Dallara race cars to compete in a head-to-head race on the IMS track.

"There's a fundamental connection between innovations on the racetrack and real-world improvements on the highway," said IMS President J. Douglas Boles. "With the launch of the Indy Autonomous Challenge, IMS continues to embrace its historic role as a catalyst for the next generation of vehicle technologies in motorsports competition and wider consumer

platforms. And while drivers will always be at the heart of racing at IMS, we're excited to be part of this groundbreaking and exciting initiative."

The purpose of the race is to promote development, commercialization and consumer knowledge of fully autonomous vehicles and advanced driver assistance systems (ADAS). The hope is that the competition will create a pool of young engineers ready to develop ADAS and autonomous vehicles and that motorsports fans will learn how these systems can make everyday roads safer.

#### **SIMULATION PLAYS A KEY ROLE IN THE RACE**

As the exclusive simulation sponsor for the Indy Autonomous Challenge, Ansys will be making significant contributions, not only in software but in team training and by conducting a simulation race as part of the challenge. The simulation race will feature models of the different race teams' autonomous cars. Each team's software will drive the cars as they compete in the simulation race before the third round of the competition.



“Ansys realizes that the world is undergoing a great mobility revolution,” says Sandeep Sovani, Ph.D., global director – automotive industry, Ansys. “It’s a great transformation that is going to bring enormous new value and well-being to society at large. For instance, AVs will reduce the number of automobile accident deaths, plus it will free up our driving time and liberate us to use that time more productively.”

Sovani says saving an hour of driving time could result in a 12.5% growth in the gross domestic product of the U.S.A. alone.

Last year, Ansys announced its Ansys Autonomy tool chain for AV simulation. Two important pieces of that toolchain are being made available to students who are participating in the Indy Autonomous Challenge: [Ansys VRXPERIENCE Driving Simulator powered by SCANer](#) and [Ansys SCADE Suite](#) software development toolkit.

“Ansys has launched a major initiative on AV simulation because simulation will play a crucial role in the development of AV,” Sovani says. “Autonomous driving won’t happen without simulation to test the millions of potential driving scenarios.”

## FIVE ROUNDS TO WIN

The Challenge consists of five rounds. Teams submit a short white paper during the first round, and in the second round, teams must demonstrate vehicular automation by sharing a short video of an existing vehicle or by participating in Purdue University’s self-driving go-kart competition at IMS.

The third round of the challenge will be a simulation race, which will be held in February 2021 after a series of Hackathons hosted by ESN and Ansys. The simulation race will be a close replica of the actual race. It will be conducted inside Ansys VRXPERIENCE Driving Simulator powered by SCANer. Inside of that giant simulation will be a replica of the Indy Motor Speedway with each team’s race car piloted by the autonomous driving software the students created. Each team will have free access to:

- Ansys VRXPERIENCE Driving Simulator powered by SCANer
- Ansys SCADE Suite software development toolkit
- Simulation training
- 3D models of IMS and race vehicles

These tools offer the teams the technology they need to develop their autonomous systems. Each race car will have models of the entire sensor suites and connected vehicle dynamics in order to simulate the Indy Lights race car.

The race will start when the simulation starts running, then all the teams are hands off while they watch their cars simultaneously race around the track. The winners of the virtual race will win the Ansys Indy Autonomous Challenge Simulation Championship cash prizes totaling \$150,000.

In the fourth round, teams will test their autonomous car software on the IMS racetrack. These tests will ensure that the car meets

## A GLOBAL EVENT

Teams from all over the world have registered for the Indy Autonomous Challenge, including:

- Ariel University, Israel
- Indian Institute of Technology, India
- Korean Advanced Institute of Science & Technology, South Korea
- Purdue University, U.S.A.
- Massachusetts Institute of Technology, U.S.A.
- Texas A&M, U.S.A.
- University of California, Berkeley, U.S.A.
- Technical University of Munich, Germany
- Warsaw University of Technology, Poland

safety and competition standards. Each team will use a standard Dallara IL-15 chassis, which is currently used in the Indy Lights series, and powertrain to ensure the focus of the testing is on the software. Through Clemson University's long-running vehicle prototype program Deep Orange, Clemson graduate automotive engineering students will collaborate with ESN and Dallara to engineer an autonomous-capable version of Dallara's 210 mph IL-15 chassis that can accommodate the competing university teams' driverless algorithms. Participating teams will be directly involved in the converted vehicle's design and specifications through monthly virtual design reviews and other feedback channels throughout the competition.

Finally, teams will race head-to-head on the Indianapolis Motor Speedway for \$1 million, \$250,000 and \$50,000 cash prizes in the fifth round. Win or lose, the teams will foster the next generation of engineers who are ready to lead the world into a more autonomous reality.

"What we're asking universities to do is hard," says Matt Peak, managing director at Energy Systems Network. "Our hope is that by bringing together and offering up to participating teams the world's premier automotive proving ground, performance chassis manufacturer, engineering research center and simulation platform, as well as nearly \$1.5 million in total cash awards, universities will see the Challenge as not just throwing down the gauntlet but also extending the helping hand to accelerate innovation and the arrival of new technologies." ▲

For more information, visit [indyautonomouschallenge.com](http://indyautonomouschallenge.com).

## START YOUR ENGINES

- Feb. 28, 2020: Round 1 close
- April 21–22, 2020: EV Grand Prix Autonomous (Optional Round 2 Qualifier)
- May 20, 2020: Round 2 close
- May 21, 2020: Hackathon #1, Fundamentals of Racing workshop
- May 22, 2020: Team Perk — Miller Lite Carb Day
- May 23, 2020: Team Perk — Legends Day presented by Firestone
- May 24, 2020: Team Perk — Indianapolis 500 presented by Gainbridge
- July 11, 2020: Hackathon #2
- Oct. 17, 2020: Hackathon #3
- Feb. 20, 2021: Simulation Race, sponsored by Ansys
- May 28–30, 2021: Official Vehicle Distribution
- May 30, 2021: Team Perk — Indianapolis 500 presented by Gainbridge
- June 5–6, 2021: Track Practice Days
- Sept. 4–6, 2021: Track Practice Days
- Oct. 19–20, 2021: Track Practice Days
- Oct. 21–22, 2021: Final Race Qualification
- Oct. 23, 2021: Final Race





# Autonomous *Safety in Sight*

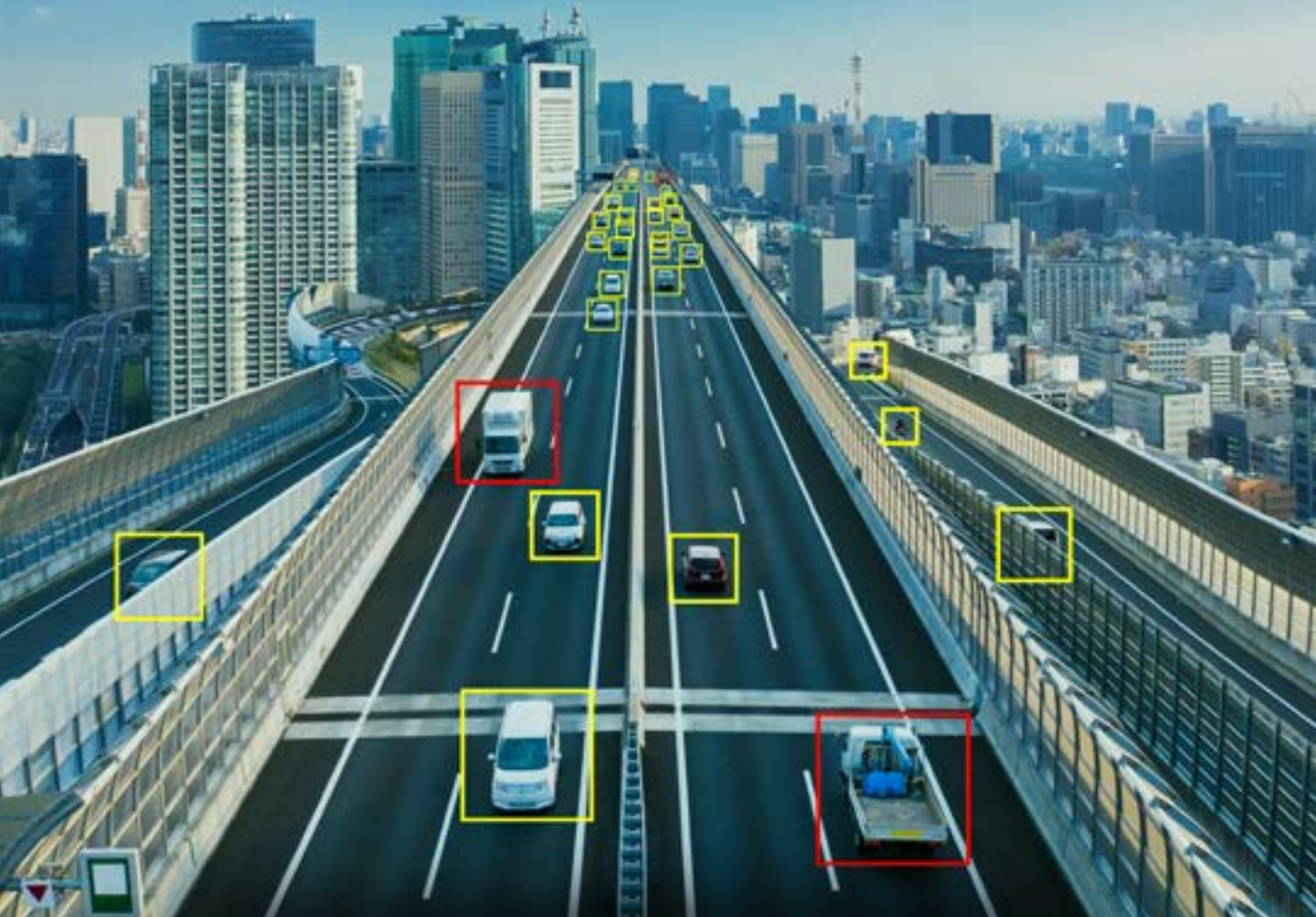

## By *Ansys Advantage* Staff

For a deployed autonomous vehicle (AV), there can be no surprises. Along the road or in the air, the vehicle's perception system must "make sense" of each object it "sees." For this to happen, its software models must be properly trained. Without this training, it will fail to detect or correctly classify objects it hasn't seen before.

As an example, consider the case of a person in a costume crossing the street: A human driver, although surprised, will immediately recognize the person in costume and respond accordingly. In contrast, a perception system may fail to make this critical leap in logic or, worse, fail to detect an object at all. To ensure safe operation, developers must not only train the vehicle's AI-based perception algorithm, but also ensure that it has learned what it needs to know.

Solving these and other safety-related AV issues is the mission of Pittsburgh-based Edge Case Research (Edge Case). Founded in 2014, Edge Case began as a collaboration between Carnegie Mellon University (CMU) researchers Michael Wagner (CEO) and Professor Phil Koopman, Ph.D. (CTO), who shared a commitment to building safety into autonomous systems from the ground up. The company's software products and services tackle the most complex machine learning challenges and embedded software problems. Edge Case works across the globe with original equipment manufacturers (OEMs), advanced driver assistance systems (ADAS) suppliers, Level 4+ autonomy developers, vehicle operators and insurers to help its customers go to market with products that are safe, secure and reliable.

"As we watched autonomy emerge from university research labs onto the roads, skies and hospitals, we realized we had an amazing opportunity to make autonomy safer and worthy of our trust," says Wagner.

The company's name aptly describes what it does. In the world of safety for autonomy and robotics, edge cases represent rare, potentially hazardous scenarios — and are the focus of Edge Case's product development. Switchboard, the company's initial offering, uses stress testing to automate



**Ansys SCADE Vision powered by Hologram speeds up the discovery of weaknesses in AV embedded perception software that may be tied to edge cases.**

and accelerate the finding and fixing of software defects. From Edge Case's inception, Switchboard has been an important component of the U.S. Army's efforts to improve soldier safety and advance tactical capabilities with autonomy platforms. Partnerships with other defense and autonomous technology companies, including Lockheed Martin, soon followed. Switchboard also served as an important conversation starter with Pittsburgh neighbor and soon-to-be partner, Ansys.

Edge Case's second innovation, Hologram, was conceived in 2018 as a robustness testing engine that detects weaknesses in perception systems. And, as the result of a 2019 OEM agreement, it also powers Ansys SCADE Vision, part of the Ansys product family for embedded software.

#### BEHIND THE AV SCENES IN THE NEURAL NETWORK

In an autonomous vehicle, perception is one of a number of interdependent systems — e.g., motion prediction, planning and control — that govern operation. With the exception of perception, developers had well-understood, accepted methods for ensuring the safety of these systems.

Perception developers typically use a drive-find-fix approach. Detecting defects requires looking at the output from a perception algorithm and comparing it against annotated "ground truth" object data. If, for example, the algorithm fails to detect a pedestrian, the process would be to retrain, retest and (likely) repeat.

This approach is adequate for development but insufficient for ensuring safety. First, ground truth data must be manually labeled — each object in each video frame. This is not only

**“Watching this disruptive, autonomous technology emerge from the labs around us, we recognized an amazing opportunity to make autonomy safer and worthy of the public’s trust.”**

— Dr. Phil Koopman, Edge Case Research

enormously time-consuming, but also outrageously expensive. Second, if a discrepancy is detected, the analysis wouldn’t identify the source of the weakness or why it happened. SCADE Vision not only addresses these issues, but also provides a tool for validating perception inside the larger autonomous system.

The core of a perception system is a set of sensors and a convolutional neural network (CNN). The network connects hundreds or even thousands of software-based neurons (single processing units) arranged in a series of connected layers. When processing camera sensor data from test vehicles, neurons in the input layer capture and assign numerical values to every pixel in an image. In this way, the CNN “sees” an image as an array of pixel values.

These values pass through filter-like layers that process each pixel through a series



**The tow truck in this four-image series is initially identified correctly, but additional analysis shows it could be a missed detection.**

of algebraic and matrix operations. Each layer’s decision function effectively screens for different object features — straight or curved edges, colors, textures, intensity patterns, etc. Based on the classification “decisions” made as the pixels are processed, the output layer identifies the presence of an object. It generates object lists and draws corresponding bounding boxes around pedestrians, stop signs, cars, etc.

Unlike a traditional software system, a neural network acts like a black box: It is difficult to impossible to know how it makes each decision. Edge Case created Hologram for precisely this reason. Managing the safety of perception systems is vastly different from validating rule-based planning or control systems. “There really aren’t any rules for detecting a pedestrian,” says Wagner, “and this is why handling the safety of perception systems is so different from validating rule-based planning or control systems. A neural network is built according to the training data it was fed.”



**Ansys SCADE Vision powered by Hologram looks back in time to identify edge cases that real-time monitoring alone does not detect, providing insight into the “black box” of neural networks.**

A case in point: An object detection system, which was repeatedly and correctly identifying pedestrians along a city street, failed to detect a worker at a construction site. Why? Because it had no reference in the training data for the worker’s neon yellow vest. Ironically, the high-visibility vest caused the worker to disappear.

#### **ANALYZING RAW, UNLABELED DATA**

Over millions of road miles, test vehicles collect petabytes, or even exabytes, of data — of which only a fraction will be used for object detection training. This is because the data must first be labeled.

Annotation experts have to draw boxes around and label every object in every frame of video, so the CNN can learn “this is a pedestrian, this is a car.” Approximately 800 human hours are required to label just one hour of driving footage — a resource-draining, error-prone proposition.

SCADE Vision powered by Hologram doesn’t require labeled data to identify fragilities in a neural network. Once a perception algorithm has been “satisfactorily” trained, SCADE Vision’s automated analysis begins by running raw video footage through the neural network (referred to as the system under test, or SUT). Then it modifies the video scene, ever so slightly. The image may be blurred or sharpened, but not to the degree that a human wouldn’t recognize the altered objects. Once again, SCADE Vision runs the modified frames through the SUT and compares the modified and baseline results frame by frame.

Edge Case Research’s product manager, Eben Myers, says the heart of SCADE Vision’s automated analysis resides in the comparison of the two sets of object detections. This is where the software engine detects edge cases and reduces petabytes of unlabeled test data to a significantly smaller subset of video frames meriting further investigation.

While minor disturbances between the detections are expected, larger disturbances (weak detections) are predictive of potential errors in the SUT (false negatives). Weak object detections signal that the software brain is straining to make a positive identification — and making a best-guess decision. False negatives, on the other hand, indicate a missed detection, an actual failure.

SCADE Vision outputs these results in two corresponding displays. A chart of the trip segment (sequential frames of video data) displays the baseline detections as gray bars, weak detections as orange and false negatives as red. And, within each frame, similarly colored (plus green for baseline detections) bounding boxes surround objects detected or missed by the SUT. Analysts can learn significantly more from SCADE Vision than from real-time analyses, as it intelligently reveals object detections in the past and in the future. For instance, a bounding box that

flickers orange in a few frames before turning (and remaining) green alerts the analyst that the SUT is confused for some reason when the object enters the scene. Without this look back, the analyst would have had no way of knowing that the green-boxed object was detected inconsistently.

SCADE Vision also finds systemic errors (versus one-offs). These present, for example, as a stop sign that shows up in several scenes, becomes a weak detection and then disappears before reappearing and repeating the pattern. This detection error could be caused by one or more triggering conditions — environmental, root-cause factors, such as glare, low contrast, noisy background (leaves on a tree), etc. SCADE Vision provides analysis tools for identifying these triggering conditions, which when combined with a weakness in the SUT, create the type of unsafe behavior the software can flag.

With these tools, analysts can add descriptive tags to the object data that characterize suspected triggering conditions and help reveal detection defect patterns. Analysts can use the output of the tagging process to perform quantitative analyses spelled out by the Safety of the Intended Functionality (SOTIF) or do additional testing on “objects of interest” in the unlabeled data. By “pointing to” these objects, SCADE Vision allows analysts to do scenario testing to see, for example, if stop signs in front of leafy trees are consistently detected. This process provides greater insight into a suspected system weakness and facilitates the retraining of the algorithm.

#### DATA LABELING BY THE NUMBERS

>24 TB data/day are generated from a 5-camera AV setup

800 human hours yield one hour of labeled data

100,000 images + one week of AI training are needed for software to learn a single traffic situation

1 M frames labeled/month are required for full-scale AV development

#### SCALING UP AV DEVELOPMENT

SCADE Vision powered by Hologram from Edge Case Research offers scalability to customers developing autonomous technology and integration with other Ansys software. It can be paired with Ansys medini analyze to discover and track identified triggering conditions. And, when used in conjunction with [Ansys VRXPERIENCE](#) and [Ansys optiSLang](#), it can automate robustness testing of the SUT over a very large number of scenario variants. SCADE Vision will also be used in conjunction with [Ansys Cloud](#) and high-performance computing (HPC) to speed the detection of edge cases at scale.

Working in partnership on perception, Edge Case and Ansys are continuing to accelerate the timeline for the safe, widespread deployment of fully autonomous vehicles.

SCADE Vision’s edge case detection capability is advancing the development of perception algorithms, while delivering a 30-times speedup in detection discovery (versus manual data analysis). What’s more, SCADE Vision can be scaled to industries beyond automotive — to mining, aerospace and defense, industrial robotics, or any application that relies on AI-based vision and perception software. ▲





# ***Take Simulation Underground***

While it would not seem to matter what is under the road an autonomous car is driving on, WaveSense engineers are using Ansys HFSS electromagnetic solutions to develop a system to map the underground features of roads for precise location verification in all conditions.

**Byron Stanley**, CTO, WaveSense, Inc., Somerville, U.S.A. and **Ansys Advantage Staff**

Ground penetrating radar (GPR) uses radar reflections of underground features to generate baseline maps and then matches current GPR reflections to those maps to estimate a vehicle's location.

In the race to create the technologies that will make autonomous driving a reality, most engineers have focused on getting sensors to detect, interpret and react to objects from the road up. To solve one of the toughest challenges — keeping the vehicle in its driving lane when the painted lane markers are in poor condition or are obscured by snow, fog or rain — engineers at WaveSense are pointing their radar devices straight down. The radar positioning system is also being actively used in parking garages, on overpasses and in parking lots.

The idea is to use ground penetrating radar (GPR) scanning at approximately 100 times per second and reaching 10 feet underground to detect the unique radar signature of subsurface objects like



**As a vehicle is driving, it localizes by scanning the subsurface and instantly matching the scans to a prior map.**

different types of soil, rocks, pipes, rebar, tree roots, etc. The resulting radar “fingerprints” are collected to create a radar map of a particular stretch of road. With this radar map stored in an onboard computer, an autonomous vehicle equipped with GPR technology can compare real-time radar signals to the map to pinpoint its position within a tolerance of 1 inch — plenty of resolution to determine whether it is drifting out of its lane.

The concept was developed by researchers at MIT’s Lincoln Laboratory around 2009. GPR was first deployed on automated 9-ton military vehicles in Afghanistan in 2013, where roads are often not clearly defined, and where drifting off the standard path might prove fatal. In 2017, MIT researchers created the spinoff company WaveSense, Inc., to design GPR units suitable for passenger vehicles and trucks for the consumer market. The WaveSense team is using [Ansys HFSS](#) to optimize radar performance while reducing costs and getting the product to market faster. The company gained access to HFSS as a member of the Ansys Startup Program.

## **THE LOGISTICS OF MAPPING THE ROADS OF THE WORLD**

Though it might seem challenging to generate underground data maps for enough of the world’s roads for general use, WaveSense offers a solid approach. First, they are starting by mapping the highest value areas — large ride-hailing markets, major parking structures and lots, and the biggest freight routes. Maps of these areas produce value from the start without offering comprehensive coverage of every street or highway in the world. Once the highest value areas are mapped, they will then spread out to the smaller traffic arteries. And, because the subsurface structure is generally stable, much of the map will not need updating for years or decades.

WaveSense does not plan to do all the mapping themselves. Besides its own fleet of vehicles, the company will work with partners who already have large fleets of trucks and cars on the road. In a nod

to the gig economy, WaveSense also is in discussions to team up with ride-hailing services and eventually mass-produced consumer vehicles equipped with map data update systems. There are a lot of ways to fill out the map, and WaveSense plans to take advantage of all of them.



**WaveSense’s product sends electromagnetic waves into the ground.**

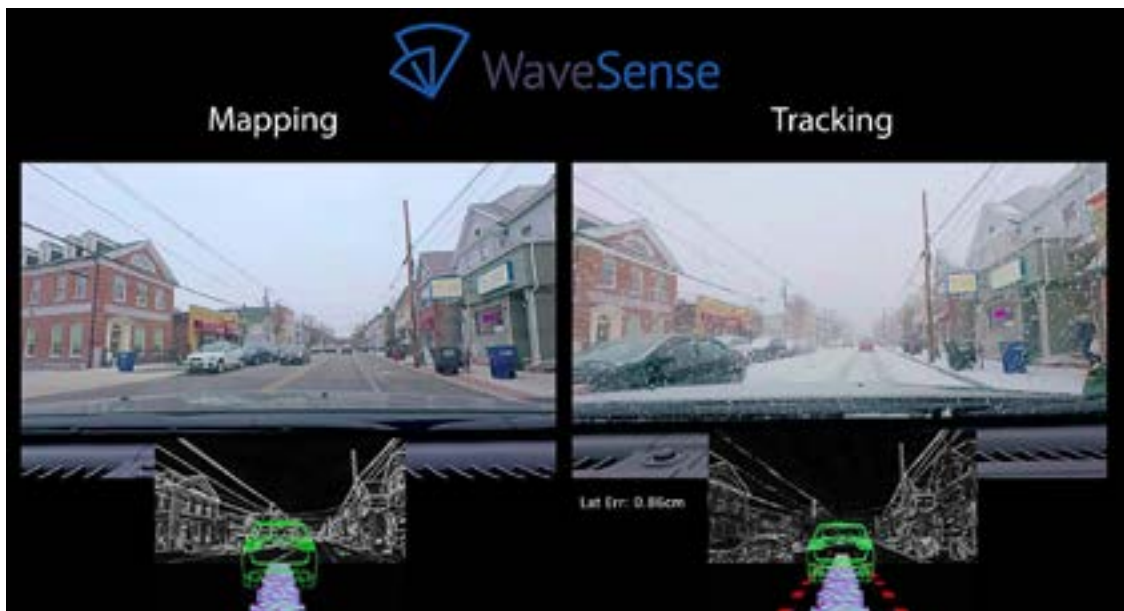

**The company measures and records reflections from underground pipes, roots, rocks and soil, and constantly updates WaveSense’s database of maps.**

**ENGINEERING AND EDUCATION CHALLENGES**

As a proof-of-principle device, the first-generation GPR units for military purposes were as wide as the vehicle itself. WaveSense is now engineering the production design — with a bill of materials less than \$100 — to fit into a 1-by-2-foot-by-1-inch footprint for installation underneath commercial automobiles and trucks. Because automakers are generally concerned about weight and space, WaveSense must miniaturize and optimize the radar antenna and associated electronics without sacrificing resolution or accuracy. HFSS enables them to virtually prototype various configurations of geometry parametrically and use optimization routines to help find ideal geometry that delivers acceptable performance.

Understanding radar gain patterns in various environments is another challenge. HFSS is helping the engineers understand how radar patterns are affected by the nearby mass of metal — the car or truck body — and the nature of the roadway materials and underground features being detected.

**SIMULATION BELOW THE SURFACE**

The WaveSense GPR system emits signals in the UHF to VHF frequency range. At these wavelengths, a great deal of character is visible from radar reflecting from underground features. Any changes in the electromagnetic properties of the road produce a unique fingerprint that is essential for creating the radar maps that make this technology viable. Though it seems like the onboard radar map would require significant data storage space, it only takes up a small fraction of the data space required by other systems in an automated vehicle.

Using HFSS, the engineers simulate various radar antenna sizes and configurations, along



**The radar positioning system is being actively used in parking garages, on overpasses and in parking lots.**



***Using simulation, WaveSense engineers are able to reach their design points in a timely manner and at a more reasonable cost.***



**WaveSense is mapping the highest value areas — large ride-hailing markets, major parking structures and lots, and the biggest freight routes — first.**

with the shape of the radar transmission energy and how it disperses into the environment. This is used to determine performance in a range of different physical environments and ground conditions. To date, they have run thousands of HFSS simulations using automated meshing with subwavelength features, including parameter sweeps, ground and vehicle effects studies, and infrastructure and material studies. Depending on the complexity, simulations take from hours to days on a 32-core server. Ansys engineering simulation technology has helped WaveSense develop a better understanding of optimal design parameters, materials and overall performance. It saves significant time and effort to simulate before building each revision of a design. Using simulation, WaveSense engineers are able to reach their design points in a timely manner and at a more reasonable cost than by building and testing physical prototypes.

#### **USING GPR IN SUNNY WEATHER**

GPR will always provide significant value in bad weather, when lane markers are not visible to the cameras mounted on autonomous vehicles. But even in fair weather, the fact is that an above-ground visual camera, lidar or other sensor will eventually fail, so having an independent GPR unit is a good idea. Fusing GPR with more standard autonomous sensors leads to substantially lower overall failure rates for autonomous systems.

In any case — rain, snow, fog or shine — WaveSense continues to use Ansys HFSS to optimize ground penetrating radar technology to create maps that most of us had never thought of — maps of the underside of the roads we drive on. **▲**



**Autonomous Vehicle Radar: Improving Radar Performance with Simulation**  
[ansys.com/about-ansys/radar](https://ansys.com/about-ansys/radar)



Metawave says SPEKTRA combines beamforming and beamsteering to reach far distances and scan the field of view in milliseconds.

# A New Kind of Eyes on the Road

*One roadblock to highly automated driving is the need to develop a sensor technology that can sufficiently detect and classify objects — especially ones that are close together — at long distances, during inclement weather, around curves and corners, and in other challenging circumstances. With the help of Ansys HFSS simulation, radar and 5G startup Metawave has built a breakthrough radar platform that overcomes these issues to help fast-track autonomous driving.*

**Matt Harrison**, Director of AI, Metawave  
Palo Alto, U.S.A.

In a perfect driving scenario, streets would be free of pedestrians, bicyclists, children playing, animals running free, trash, slick spots, traffic cones and other potential hazards, including careless or distracted motorists. Unfortunately, the real roadway is much more complicated, and today, automakers are building highly automated features that still require a driver-in-the-loop.

How can the car of tomorrow meet today's safety requirements, as well as expectations for a smooth riding experience? Automakers are determining how to provide highly automated

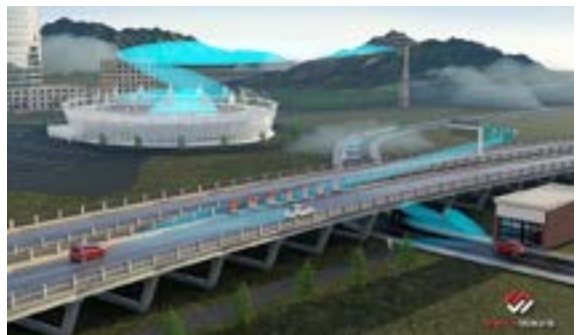

**Metawave says SPEKTRA can detect and classify roadway objects up to about 330 meters away, even in conditions that limit human visibility, such as darkness or heavy fog.**

features now, while drivers are still at the wheel, as innovative companies provide the sensors needed to ensure that we are prepared for a future with autonomous vehicles on our freeways, city streets and neighborhood roads. Cameras, lidar, ultrasonic sensors and radar — along with AI — are all being innovated to create a new world of transportation. Sensor technology for self-driving cars is big business, with the market for lidar alone reaching \$1 billion in 2019 and the automotive radar market predicted to reach \$6.61 billion by 2021.

## ENABLING HIGHLY AUTOMATED DRIVING

As Metawave set out to build an analog beamforming radar to address the inherent challenges of today's radar technologies, the company took advantage of [Ansys HFSS](#) simulation software — part of the Ansys electromagnetic suite. As a graduate of the [Ansys Startup Program](#), Metawave used the software to help develop its high-performance SPEKTRA radar.

SPEKTRA combines analog beamforming and beamsteering with advanced digital signal

processing to illuminate the driving field of view (FoV) and detect all the objects on the roadway in high resolution. Beamforming uses a pencil-like beam with high gain for reaching far distances (up to 330 meters), along with lower side lobes to reduce the probability of false target detection.

Beamsteering is used to scan the FoV in milliseconds. Combined, beamforming and beamsteering allow a high-frequency radio signal beam to be shaped and pointed in a specific direction, focusing the radar signal into a narrow beam scanned across the scene. As a result, the SPEKTRA radar enables long-range detection and greater resolution.

Integrated with Metawave's AWARE artificial intelligence (AI) platform, SPEKTRA quickly classifies objects, even those close to each other. SPEKTRA radar can detect and classify roadway objects up to about 330 meters and pedestrians up to about 200 meters. It can do this just as easily in the dark of night, dense fog, sand storms or heavy rain as it does under clear conditions.

Although Metawave designed SPEKTRA to tackle the difficult, long-range applications associated with highly automated driving, including features like highway pilot, traffic jam pilot and auto emergency braking, it is flexible enough to fit any sensor suite and can also be adapted to operate at shorter ranges.

## PUSHING THE BOUNDARIES

Metawave engineers used Ansys HFSS at the start of the development process and then again to integrate components such as the radome and enclosure. By simulating SPEKTRA's phased array antenna and printed circuit board (PCB)-type feed network to

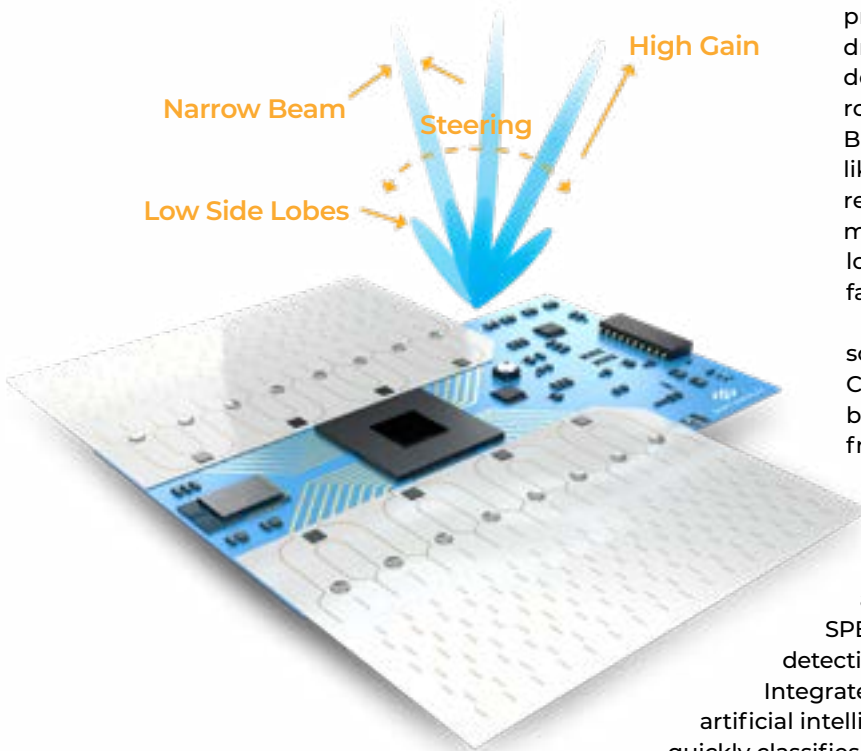

**By simulating SPEKTRA's phased array antenna and printed circuit board-type feed network, Metawave predicted the behavior of the beam at all angles and pushed the boundaries of radar specifications.**

## TODAY'S SENSING

The current breed of sensors can fall short. Cameras have very high resolution, but they can only see out about 50 meters. Lidar can see faraway objects, but most of these platforms are expensive and big, and they can't see in the dark or inclement weather. Today's digital beamforming radar can see in the dark, but it has trouble distinguishing between objects.

The truth is, all of these sensors are important; they exist for different reasons, and they provide different information so that the vehicle can operate smoothly and safely. But what is the missing sensor today? Metawave thinks it's long-range analog radar.



**Integrated with Metawave's AWARE artificial intelligence platform, SPEKTRA classifies objects, even those close to each other, at long range with high angular resolutions.**

carry information to the antenna, Metawave predicted the behavior of the beam at all angles and pushed the boundaries of radar specifications, including:

- Narrow beam for high resolution, which allows SPEKTRA to detect adjacent targets at long range
- Low side lobes, to reduce the probability of false detections
- High gain, for target detection at greater distances
- Instantaneous illumination of the field of view to track the direction of all surrounding targets

By using the adaptive meshing and 3D component features in Ansys HFSS, Metawave avoided the risk of under- or over-meshing, which can lead to a loss of accuracy. Ansys' adaptive meshing also helped preserve subcomponents' parameters within the larger model.

Because Ansys HFSS includes multiple solvers within the same user interface and has a streamlined simulation model setup process, engineers could quickly begin the design process, which contributed to a shorter development cycle and lower costs.

#### **DESIGN FOR MANUFACTURABILITY**

Whether a product is as simple as a wooden dowel or as complex as AI-integrated radar, how it will be manufactured is an important consideration throughout the product design and development process. Ansys HFSS enabled Metawave engineers to quickly weigh the advantages and disadvantages of multiple designs, envision the final product, and verify their hypotheses about performance and manufacturability.

Specifically, Metawave engineers wanted to be certain that the prototype design could withstand the variations required by PCB manufacturing tolerances and still deliver optimum performance. Adding the Ansys Optimetrics toolbox to Ansys HFSS provided statistical capabilities that enabled them to gauge the feasibility, flexibility and robustness of the proposed prototype.

#### **THE ROAD TO AUTONOMY**

Metawave began delivering its first-phase proof-of-concept product to leading automakers and Tier 1 transportation providers in 2019. Its advanced beamsteering capabilities are designed to help the industry move from driver-assisted automobiles to fully autonomous vehicles, and to do it safely, regardless of what else is on the road. ▲

# Out of Thin Air

Providing the power to keep billions of Internet of Things (IoT) sensors going is a daunting task that can stress the electric grid, require huge ongoing maintenance costs and create a battery-recycling nightmare. Using Ansys HFSS and Ansys Electronics Desktop, Teratonix designed a radio frequency harvester that can collect ambient RF signals and convert them to electricity.

By **Yi Luo, Founder**, Teratonix, Pittsburgh, U.S.A.

Sensors are the eyes and ears of our increasingly digitalized world. By perceiving, recording and processing data, and reporting on what is happening around us, wireless sensors help connected devices make smart decisions about everything from patient care to process controls to turning on the porch lights.

Without sensors, the IoT would be at a standstill. Instead, analysts predict there will be 42 billion connected devices by 2025<sup>1</sup> when the sensor market will be valued at more than \$34 billion.<sup>2</sup>

But that progress comes at a cost. It takes an enormous amount of energy to keep those devices running and process all that data, and that can take a toll on the environment, not to mention how costly conventional power sources such as electricity and batteries can be.

Running even low-power sensors can be a drain on the electrical grid and increase CO<sub>2</sub> emissions. Battery-powered devices avoid those problems but create others: Batteries are expensive to install, short-lived and difficult, even hazardous, to recycle. Some sensors are most

useful when they're collecting data in harsh or dangerous environments, but trying to change a battery there can be problematic at best, if



**Prototype of an industrial IoT sensor node. Multiple sensors, a microprocessor and a wireless data transmitter/receiver are powered by the Teratonix ambient RF harvester, composed of an antenna, RF-to-DC converter integrated circuit, and DC regulation and storage circuit.**

not downright treacherous. Estimates suggest there will be 500 billion sensors operating around the globe as early as 2035, and it's nearly impossible to imagine replacing the billions of batteries that will die every year. So the question is: How will we power all of those sensors, easily, affordably and without contributing to climate change?

After all, you can't pull energy out of thin air. Or can you?

Teratonix does. The company's patented radio frequency (RF) energy harvester collects the ambient RF signals that swirl about and converts them to electricity. The Teratonix harvester produces a clean source of electricity that will enable the deployment of billions of battery-less, maintenance-free, wireless IoT sensors for low-power, long-range and short-range applications.

**SIMULATING POSSIBILITIES**

The RF-to-DC process begins when an antenna captures the radio waves that circle all around us. These radio waves create a changing potential difference across the length of the antenna — anywhere from 2 to 10 inches — that the antenna's charge carriers attempt to equalize. The harvester's RF-to-DC integrated rectifier circuit then captures the energy produced by the movement of the charge carriers, which is in turn temporarily stored by a capacitor that amplifies the DC output and connects it to the load.

Teratonix used [Ansys HFSS](#) simulation software to develop the harvester's high-gain, 100 MHz–6 GHz broadband antenna and [Ansys Electronics Desktop](#) to facilitate design of its

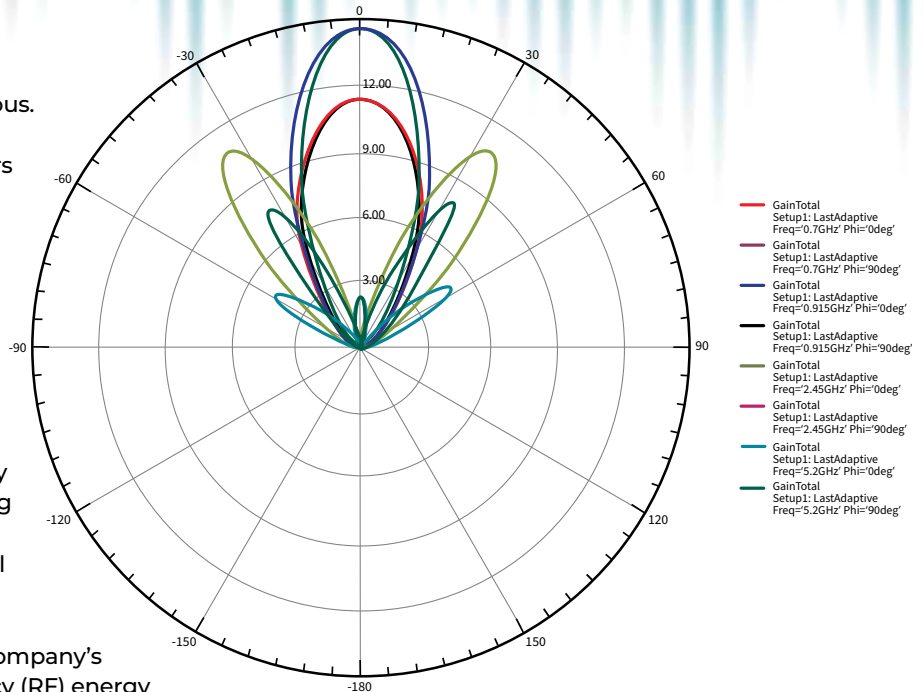

**Simulated broadband antenna gain as a function of incidental angle, generated with Ansys HFSS**

impedance-matched rectifier. For Teratonix, a member of the [Ansys Startup Program](#), there was no “going back to the drawing board” paper-and-pen option for designing its RF harvester: Without being able to model such properties as gain, directionality and electrical impedance, there would have been no product.

**BREAKTHROUGH TECHNOLOGY**

The idea of converting “free” cellphone, TV, radio and even Bluetooth signals to DC is nothing new. The industry had been considering it for years but was limited by the fact that the available diode technology could only capture RF signals of a single frequency and yielded very low conversion efficiency. The development of a high-responsivity metal-semiconductor-metal (MSM) diode by Carnegie Mellon University scientists changed that, unleashing the potential to collect broadband signals from

## ***Using Ansys HFSS, Teratonix modified standard bow tie and log spiral antennas, and then determined which iteration would provide the desired broadband performance quality.***

the full RF spectrum — and to do it up to 1,000 times faster than a single frequency diode could. This brought the development of RF harvesting technology within reach.

Still, commercialization depended on creating a multiband antenna with high gain that could receive both horizontally and vertically polarized waves. Teratonix achieved this breakthrough goal with Ansys HFSS, which provides 3D electromagnetic design and simulation capabilities.

### **CRITICAL CONFIGURATIONS**

Using Ansys HFSS, Teratonix modified standard bow tie and log spiral antennas, and then determined which iteration would provide the desired broadband performance quality. By modeling various antenna characteristics, Teratonix engineers could quantify how directionality and broadband angle sensitivity affected gain and interference. In addition, the frequency domain solvers within Ansys HFSS enabled engineers to interpret how well the antenna can couple with the harvester's circuit throughout the target frequency range. Solve times ranged from as little as 15 minutes for simpler designs to as long as two hours for more complex antennas.

Moving forward, Teratonix intends to use Ansys software to optimize signal connectivity and signal and power integrity.

Antennas are just part of the RF-to-DC equation, of course. Once the signals are captured, an effective rectifier must efficiently convert them.

To accelerate the design of their rectifier's integrated circuit (IC) — which incorporates a proprietary ultra-high-speed diode — Teratonix used Ansys Electronics Desktop. The platform produced detailed information about circuit performance as a function of RF frequency and input power, providing a measure of DC output and increasing confidence in the IC's ability to change RF signals to electricity as quickly

as possible. Ansys Electronics Desktop also helped engineers evaluate different IC materials, critical dimensions and configurations for complete RF-to-DC conversion and affordable manufacturing. Combining the software with open-source SPICE enabled time and frequency domain simulations of circuit operation.

Without simulation, engineers might not have been able to even begin designing the RF harvester. Using Ansys software provided the precise answers they needed to develop the prototype, which made its official debut at the January 2020 Consumer Electronics Show.

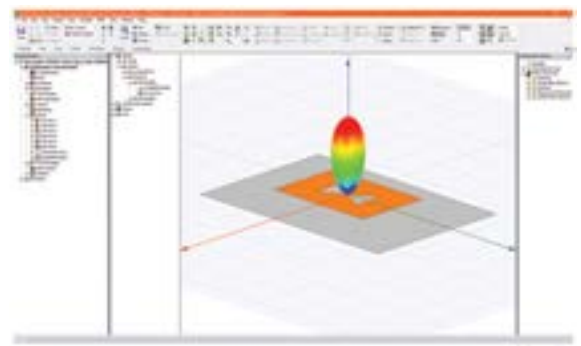

**Sample 3D bow tie antenna gain plot in Ansys Electronic Desktop**

### **MORE POTENTIAL ENERGY**

As the IoT market explodes, the impact is being felt everywhere — even in the air around us. It is filled with ambient RF signals, and as 5G and advanced Wi-Fi proliferate, the space is only going to get more crowded.

Capturing these ubiquitous signals that would otherwise go to waste will help power the next generation of “smart” devices, and do it faster than ever, while also constraining costs and protecting the environment. ▲

1. [idc.com/getdoc.jsp?containerId=prUS45213219](https://www.idc.com/getdoc.jsp?containerId=prUS45213219)
2. [mordorintelligence.com/industry-reports/iot-sensor-market](https://www.mordorintelligence.com/industry-reports/iot-sensor-market)



# *Elastic Compute & Big Data Analytics Tackle* **Physical Verification Complexity**

By **Nitin Navale**, CAD Manager, Xilinx, San Jose, U.S.A.

**L**arger, more complex silicon designs are straining verification methodologies and slowing time to results and time to market. Xilinx engineers wanted to leverage big-data analytics to simplify their verification flow on leading-edge chips, and they looked to Ansys for answers.

Many of today's rapidly evolving applications — be they in artificial intelligence, autonomous vehicles, infrastructure or high-performance computing (HPC) — rely on leading-edge field-programmable gate arrays (FPGAs) for their performance and flexibility.

Silicon design trends — and their attendant pressures for more performance and functionality — flow back upstream to engineers at Xilinx, the venerable 35-year-old Silicon Valley company that invented field programmability. Owing to their unique programmable architecture, FPGAs have always been relatively larger devices than standard integrated circuits or custom systems-on-chips (SoCs), and lately the explosion of new features on the company's Versal ACAP products has only made them larger and more complex.



Further, ultra-low voltages lead to razor-thin noise margins, so variability can be severe. This affects timing, where the timing delay variation as a function of voltage is changing with each node.

With billions of instances and transistors, these FPGA designs require higher capacity and enough scale and coverage (50x more than the traditional approaches to dynamic analysis and static signoff) for proper timing analysis. If tool capacity is already limited, teams usually aren't in a budget or time-to-market position to afford running longer simulations or more simulation cycles to get proper coverage.

Other issues to consider include the complexities of 2.5D and 3D package routing and techniques such as chip-on-wafer-on-substrate (CoWoS), aging-induced stresses on fin field-effect transistors (FinFETs), as well as thermal and Joule heating. Additionally, designers need to model the chip, package and system together to ensure a sound overall power delivery network.

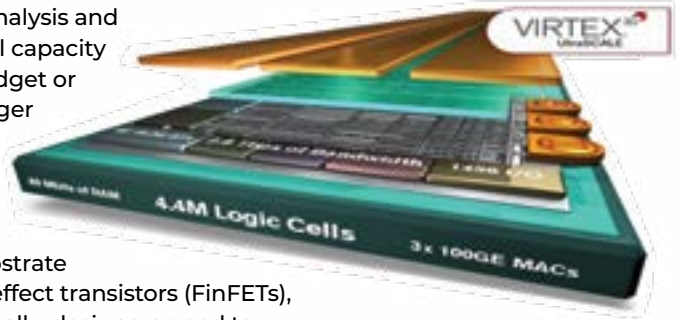

**The Xilinx XCVU440 can contain up to 400 fabric sub-region (FSR) instances, each with up to 5,000 IP block instances.**

### WRESTLING WITH COMPLEXITY

Confronted with this kind of complexity, the team at Xilinx has adapted to take on these verification challenges. The company has embraced big data analytics and elastic compute functionality, powered by Ansys, which speeds the designs to completion while accurately covering multiphysics issues that can vary significantly on chip.

One of the company's newest products is the Xilinx XCVU440, which contains 30 million ASIC gates. Any product from this family can contain up to 400 fabric sub-region (FSR) instances, each with up to 5,000 IP block instances. (An FSR is the next-largest building block below the full chip.) The IP blocks are heterogeneous in nature — custom, semi-custom, digital and mixed signal.

Xilinx has no shortage of experience with static timing analysis (STA), but modern STA is becoming an increasing challenge with greater feature complexity at finer process nodes. The company needed accurate modeling for supply voltage and wider coverage. With billions of instances and transistors on a single die, engineers needed higher capacity from a solution that can scale with enough coverage.

Traditionally, to perform STA on a sub-region, the designer would load the entire chip into the tool and black-box regions that didn't need their attention. But it's proving more and more difficult to isolate or prune parts of the design to do STA, and scaling with traditional methods has started to break down. And even black-boxed IPs can consume memory and affect tool performance! The traditional approach works best for large blocks that have few instances, and XCVU440 is just not that kind of beast.

Instead, the team investigated a subsystem approach that would simplify the STA challenge and speed time to results without compromising accuracy. They chose to leverage [Ansys SeaScope](#), a purpose-built big data platform that delivers elastic compute functionality and distributed file/data service.

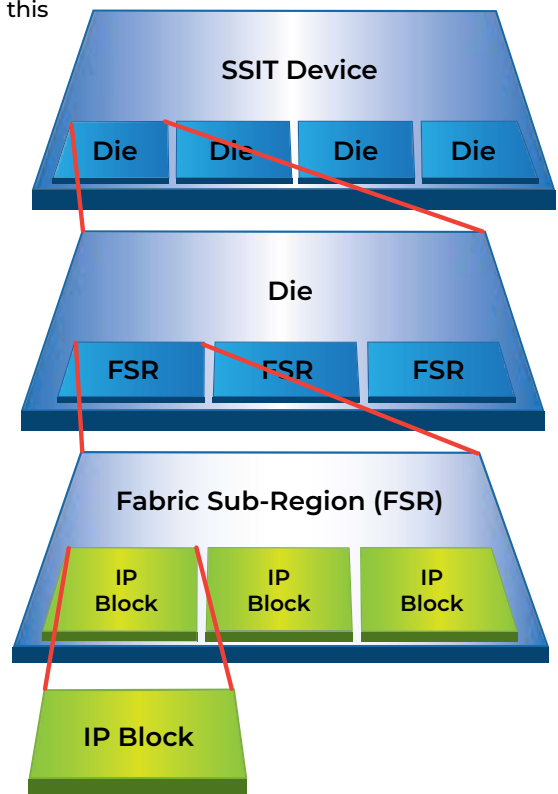

**Silicon interconnect technology devices contain multiple dies on a silicon interposer. A single die can contain between 100 and 400 fabric sub-region (FSR) instances. The FSR typically has 2,500 to 5,000 instances of IP blocks.**

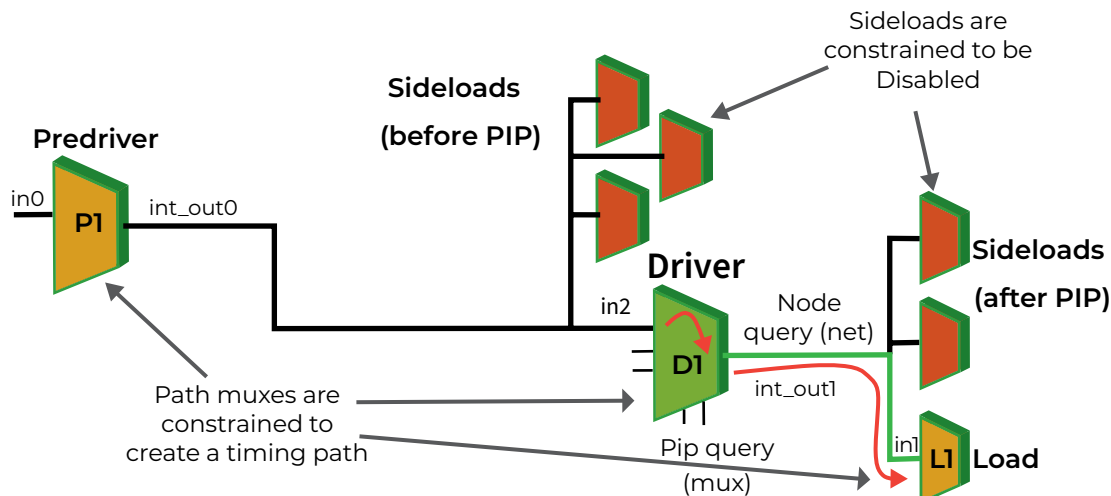

**Xilinx has an internal process called Timing Capture, which requires not just a physical view of the chip, but also awareness of its point-to-point interconnect delays. Instead of timing for the whole design, Timing Capture focuses on a subset of highly critical interconnect paths.**

SeaScope can handle large designs and distribute them efficiently across the compute farm on smaller CPUs with smaller memory footprints. From this platform, they were able to load the chip and prune it down to create a virtual design for STA analysis that was composed of only the most relevant aspects of the full device.

***With simulation data sizes growing to unmanageable dimensions, Xilinx leveraged Ansys SeaScope and its map-reduce analytics to prune chip-scale designs for faster timing analysis.***

#### **USING ANSYS SEASCOPE FOR LARGE DESIGN SCALING FOR TIMING ANALYSIS**

The design team started by loading the entire chip into SeaScope as an abstracted physical view — DEF and SPEF (Design Exchange Format, Standard Parasitic Exchange Format) for chip-level blocks and LEF (Library Exchange Format) for IP blocks — and pruned it down to contain only the precise list of IP instances desired for that downstream analysis. Within SeaScope, they could easily delete unwanted IP instances, then delete any nets that were left floating. To ensure no capacitive loading is lost, all dangling coupling caps were attached to a virtual aggressor. The final view is reduced in scope from the original chip, containing the precise IP instances needed for analysis with no loss of accuracy.

From there the team could export pruned Verilog, DEF and SPEF views that could be loaded into other analyses.

Xilinx ran an experiment using a single FSR on a “mini-SoC,” containing roughly 375,000 block instances. Had the team not filtered it, but run the pure FSR as is, their STA timer wouldn’t have been able to handle its size. The pruning job, which Ansys SeaScope manages seamlessly, required only 40 SeaScope workers and yielded a 6.5-hour runtime. STA is then able to handle the pruned design in a very respectable 12 hours per corner (wall clock time). Interestingly, pushing the same design through [Ansys Path FX](#) yielded a runtime of only one hour per corner (using one master license and 42 workers).

The team then ran the same test on a medium-sized multi-FSR experiment (33 FSRs and 32 million block instances). As before, STA could not finish on the unpruned design. After pruning, STA is now finishing with a wall clock time of four days per corner. Once again, Path FX is still faster with a one-day turnaround.

What the team accomplished was to take a near full-chip version of the design, prune it down to fit inside their STA tool, and achieve signoff in a reasonable amount of time.

**ANSYS REDHAWK-SC:  
FUTURE-FRIENDLY FULL-CHIP EM/IR SIGNOFF**

In parallel with this effort, another Xilinx team was using Ansyes RedHawk-SC for EM/IR signoff to see how that tool handles complexity and scale on the same full-chip scale. The goal with EM/IR signoff is to partition the chip into something that can be handled on a 1-2 TB host and run overnight, preferably in under eight hours.

To better grasp the increase in design complexity at later technology nodes, Xilinx's 16 nm UltraScale+ design can be used as a point of reference. The team signed off EM/IR for that entire chip by dividing it into seven partitions, which took about one person-month for initial setup. Iterative reruns with ECOs consumed roughly one person-week to cover

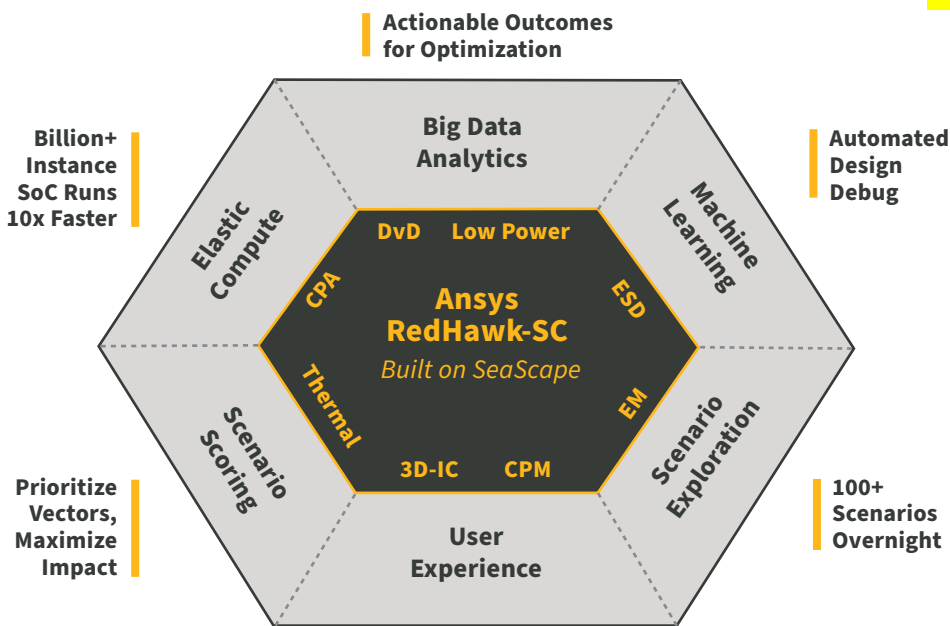
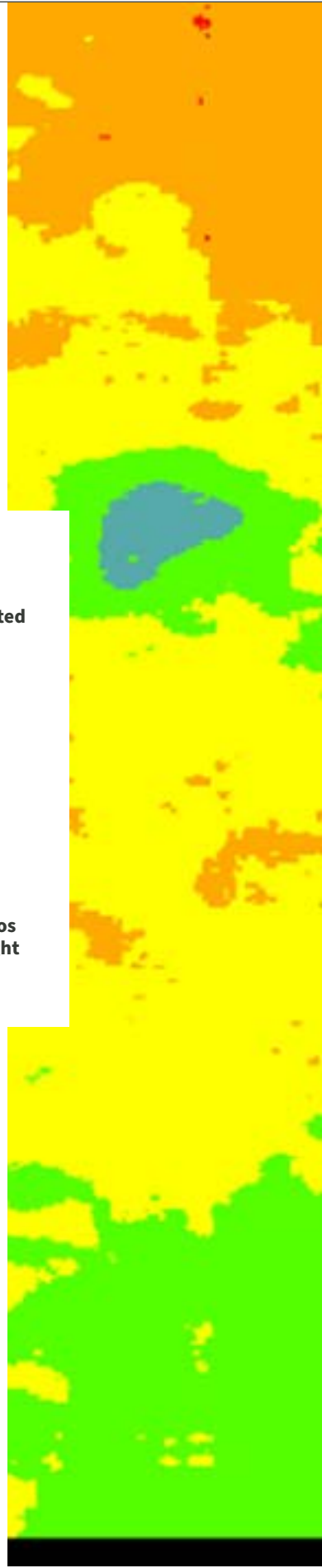

the whole chip. To achieve the same tool capacity and analysis throughput, the 7 nm Versal chip required 40 partitions and 5x the engineering person-hours to finish along the same timeline. That sort of resource investment simply cannot scale into the future.

But unlike with STA, this time Xilinx engineers were able to feed the unpruned data set directly into RedHawk-SC, which is built on top of SeaScape and thus handles the pruning natively. In the experiment, the team analyzed a medium-sized place-and-route block for static IR drop (the DC voltage that is lost across the power delivery network due to its electrical resistance), comparing a four-core classic RedHawk run against a 16-core RedHawk-SC run. The test case saw 57-minute wall clock times with classic RedHawk compared to 18 minutes for RedHawk-SC, which is a good baseline for additional comparisons. The next comparison tested a very large place-and-route region containing 78 million logic gates — once again running static IR drop in both tools. Classic RedHawk maxed out at 16 cores on a single host, while RedHawk-SC comfortably scaled up to 136 cores across the LSF farm.

Because RedHawk-SC is partitioning the design across so many machines or workers, the experiment required only 29 GB of peak memory per worker, versus 655 GB peak memory with classic RedHawk.

	Ansyes RedHawk	Ansyes RedHawk-SC
Core count	16	136
Wall time	22.5 hours	2.5 hours
Peak memory	655 GB	29 GB
Node count	717 M	1.42 B
Resistor count	1 B	1.98 B

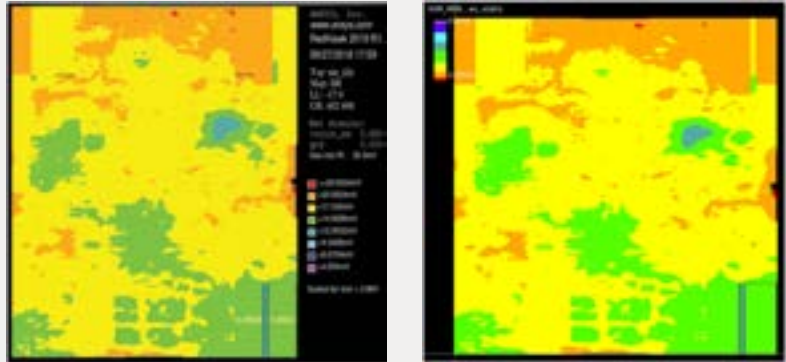

Comparing wall clock times, RedHawk-SC's distributed compute finished the static analysis in a mere 2.5 hours, compared to 22 hours for classic RedHawk.

The result was a noteworthy improvement in performance. RedHawk-SC is enabling faster turnaround and distributed compute, and it's doing so with finer granularity than classic RedHawk. There's no doubt: This is the future of EM/IR analysis.



**Xilinx Versal is an adaptive compute acceleration platform (ACAP), a new category of heterogeneous compute devices.**

**ANSYS PATH FX: ELASTIC COMPUTE ON CHIP-SCALE INTERCONNECT DELAYS**

In addition to traditional STA Timing Closure, Xilinx has an internal process called Timing Capture, which is specific to its all-programmable architecture and is driven by the company's Vivado software. Vivado is the tool that programs the chip and is like a full implementation flow unto itself. Timing Capture requires not just a physical view of the chip, but also awareness of its point-to-point interconnect delays.

Because it would be impractical to calculate these delays while programming the chip, Xilinx instead pre-calculates them while designing the chip and then programs the delays into Vivado. The tool is thus already aware of interconnect timing at various PVT corners and uses that timing to optimize the chip during programming. The process for measuring these delays is similar to critical path timing analysis in traditional STA. Instead of timing for the whole design, Timing Capture focuses on a subset of highly critical interconnect paths outlined by Vivado.

For a traditional STA tool, every conflicting path must be handled separately. Each conflict means a separate call to update timing. Even for paths that can be grouped together, the process is time-consuming. Xilinx wanted better throughput and parallelism without sacrificing accuracy.

The team turned to Ansys Path FX for critical path timing analysis, which can calculate pin-to-pin delays simultaneously across the entire chip — even on conflicting paths. Ansys Path FX accomplishes this feat by applying constraints to each path independently and then distributing the many paths across many workers fully in parallel.

Delay calculations based on the FX transistor-level simulation model mean no accuracy loss.

This is where elastic compute comes into play: You can farm out all these paths as small jobs to many hosts across your LSF (load-sharing facility) farm.

The team ran a head-to-head test comparing the performance of Path FX versus their traditional STA signoff tool on 95,000 query paths. In the test, creating the database took one hour of wall clock time in the company's trusted STA tool, but only 15 minutes in Path FX with similar memory footprints (~55 GB).

The next stage — path delay calculation — is where Path FX really shined. The incumbent STA tool required 190 separate tool invocations and nearly 2,000 compute hours to finish measuring all paths. Wall clock time is difficult to precisely nail down, because the team employed many tool invocations running in a semi-parallel LSF configuration. In the best (and most expensive) case of running all 190 tool invocations fully in parallel, the best possible wall clock time would be 3.5 hours. More realistically, it was likely closer to 100 hours. Meanwhile, Path FX's native parallelism allowed it to complete the same task with a single tool invocation and a mere 7.4 compute hours. Wall clock time for Path FX was a very crisp 21 minutes.

		CPU	Wall Clock Time	Maximum Memory	Tool Licensing	Number of Cores
Create database	STA tool	2 hrs	1 hr	58 GB	1 license	4
	Ansys Path FX	3.5 hrs	15 minutes	55 GB	1 manager, 42 workers	42
Path delay calculation	STA tool	1,990 hrs	Ser: 655 hrs Par: 3.5 hrs	46 GB	190 licenses	760 (4 per run)
	Ansys Path FX	7.4 hrs	21 minutes	12 GB	1 manager, 42 workers	42

The results greatly exceeded the design team's expectations. With the team's semi-parallel approach using the traditional STA tool, they'd grown accustomed to this work taking a week.

Path FX's configuration (one license and 42 workers) comes out looking more cost-effective than 190 licenses of the traditional STA tool.

### BIG, FAST AND ACCURATE

To break through modern simulation bottlenecks, Xilinx has rethought its design methodologies and embraced new approaches using Ansys tools. These tools have proven they can dramatically speed up time to results without sacrificing accuracy when it comes to timing and EM/IR analysis. In doing so, Xilinx has embraced an approach already championed by companies such as Twitter and Amazon: big data analysis.

With simulation data sizes growing to unmanageable dimensions, Xilinx leveraged Ansys SeaScape and its map-reduce analytics to prune chip-scale designs for faster timing analysis. Similarly, RedHawk-SC and Path FX use intelligent pruning and partitioning, coupled with elastic big data compute, to break down each mammoth EM/IR or interconnect timing job into a stack of bite-size chunks. In all aspects of back-end analysis, the next generation of silicon will be relying on Ansys tools to make it out the door. ▲

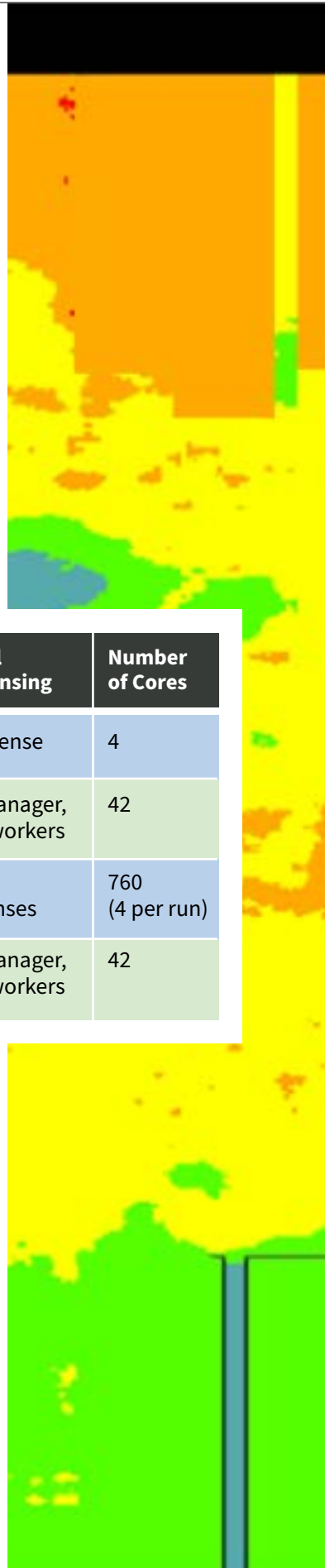

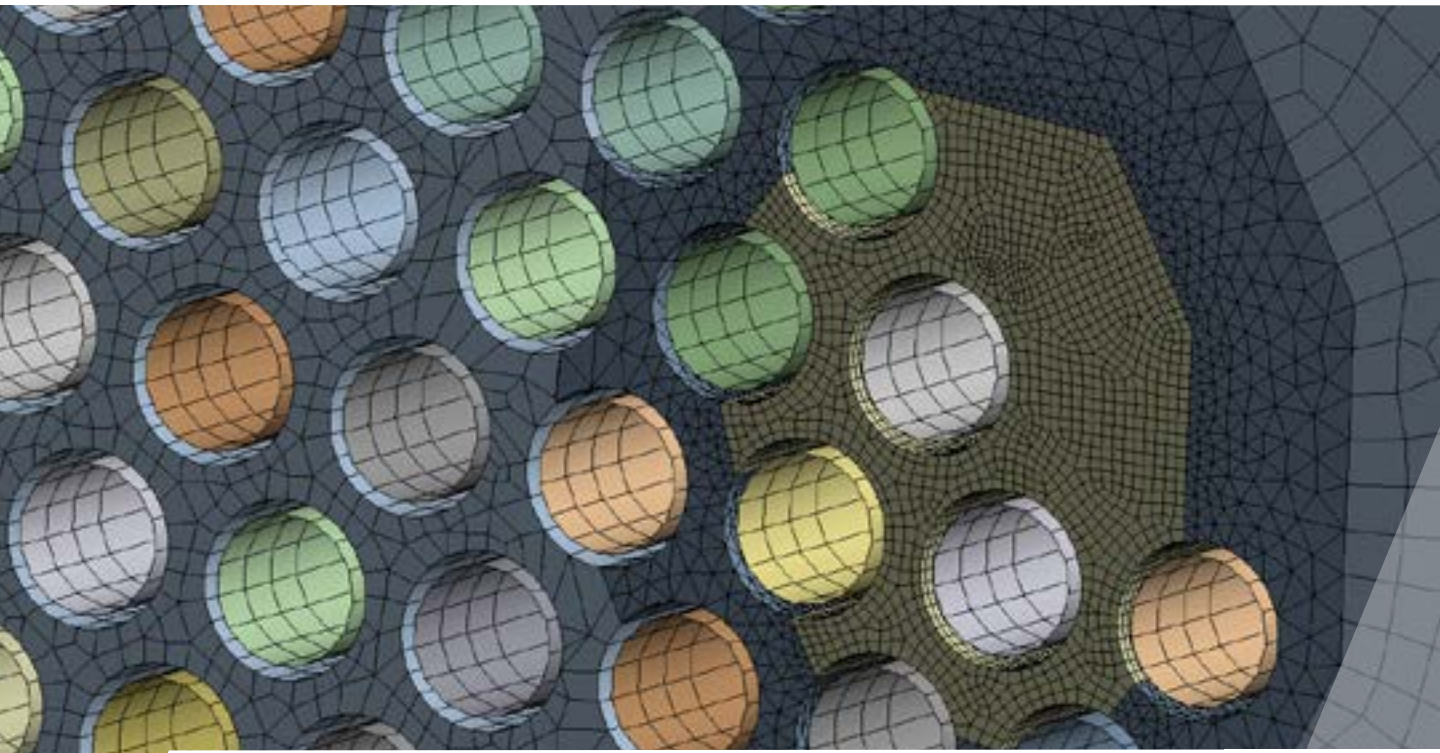

# *Rapidly Meet* **Heat Exchanger Regulations**

By **Richard Grant**, President, Grantec Engineering Consultants Inc., Halifax, Canada

Because of the potential for high operational pressures and the consequences of failure (which could include personal injury, equipment loss, and/or decreased output and revenue), shell-and-tube heat exchangers are classified as pressure vessels. Pressure vessels are strictly regulated in North America and elsewhere in the world. To commission a new design requires regulatory approval. Heat exchangers with symmetric tube layouts can typically be assessed using codes such as the American Society of Mechanical Engineers (ASME) Boiler and Pressure Vessel Code (BPVC). However, for exchangers with highly asymmetric tube layouts, simulation is often the only cost-effective way to qualify these designs. Ansys Mechanical software was recently used by Grantec Engineering to perform finite element analysis (FEA)-based strength assessments for a range of condenser and evaporator heat exchangers to gain rapid approval from regulatory authorities.



**Assessing Fluid Flow, Heat Transfer,  
Structural Response and Fatigue**  
[ansys.com/exchangers](https://www.ansys.com/exchangers)

## *Asymmetric design provides substantial improvements in performance over the life of the heat exchanger.*

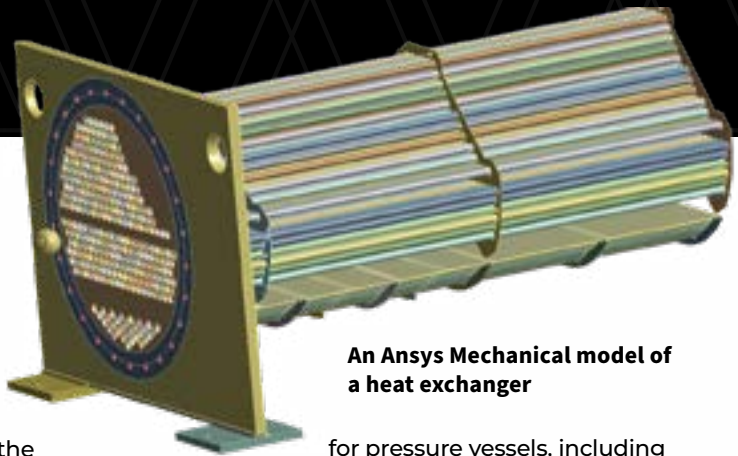

**An Ansys Mechanical model of a heat exchanger**

A decade or two ago, nearly all heat exchangers were designed with symmetric tubesheet layouts that were relatively simple to design and validate. However, symmetrical designs can be inefficient if the flow through both the tubes and the shell is unevenly distributed, resulting in wasted thermal energy. In recent years, computational fluid dynamics (CFD) software, such as [Ansys Fluent](#), has simplified the process of simulating the flow of fluid through both sections of the heat exchanger. Engineers obtain key insights like the flow distribution in the tube and shell, recirculation zones, areas of greater and lesser heat transfer, temperature of the casing, pressure on the casing, etc. This information makes it practical to optimize heat transfer capacity and pressure drop by designing the shell-and-tube layout for more uniform and efficient flow patterns. The resulting asymmetric design provides substantial improvements in performance over the life of the heat exchanger.

Grantec was retained to evaluate the design of numerous heat exchangers for a large international manufacturer of heating, ventilation and air conditioning (HVAC) equipment. These assessments needed to be performed based on the ASME BPVC requirements. Before the equipment could be marketed in Canada, it also needed to meet the Canadian requirements

for pressure vessels, including requirements contained within the Canadian Standards Association (CSA) B51 “Boiler and Pressure Vessel Code.” To assure compliance with both the ASME and the CSA B51 requirements, Grantec simulated the designs with [Ansys Mechanical](#) because the software handles very complex nonlinear mixed-mesh models that have a large number of contacts.

### **HEAT EXCHANGER ASSESSMENT**

Grantec assessed numerous exchanger configurations with varying parameters, including a range of different shell diameters and exchanger lengths, and multiple tubesheet arrangements ranging from about 200 to 500 tubes. Many of the tubesheet arrangements were highly asymmetrical so compliance could not be assessed with the ASME code equations, which are mainly applicable to symmetric tubesheet patterns. Some of the models developed had as many as 500 contact regions. Further, the tubes in these heat exchangers are not smooth, but have both internal and external fins to increase the surface available for heat transfer.

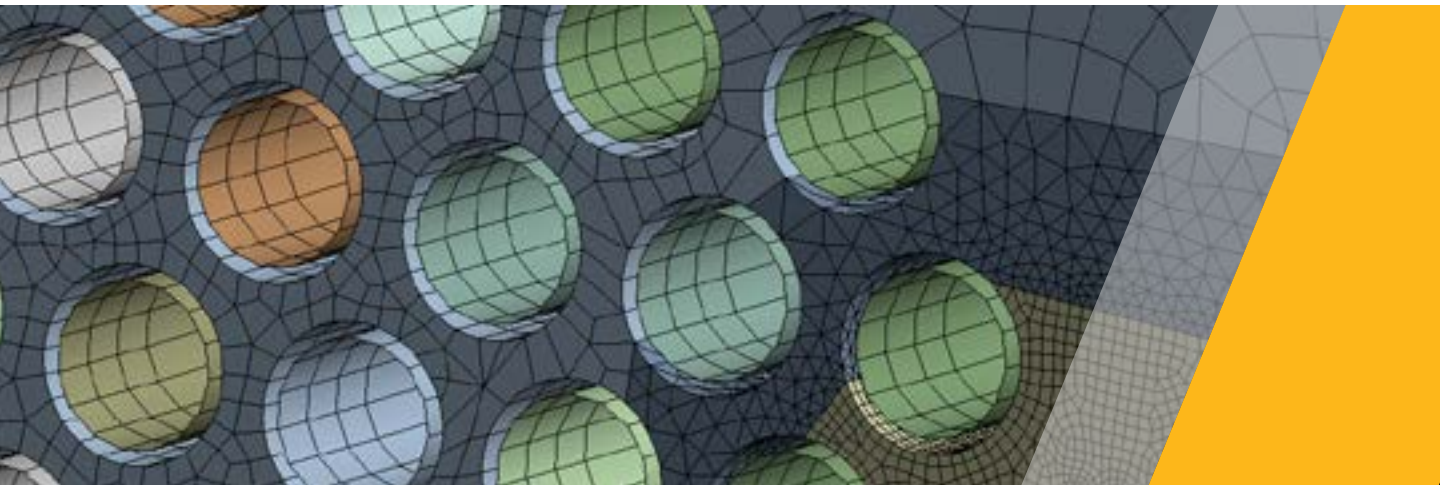

Simulation models were developed to assess the effect of the fins on the longitudinal and radial moduli and the Poisson effect. The Poisson effect (the same effect that causes a rubber band to become thinner as you pull on it) causes the tubes to contract longitudinally as they are internally pressured and expand longitudinally as they are externally pressured. For the exchangers considered, the tubes are “rolled” (i.e., expanded) into the tubesheets at both

between the tubes, the baffle plates and the shell. The arrangement resulted in an accurate model of the restraints, forces and stresses generated, which was necessary to qualify the design.

#### **CALCULATING VALUES REQUIRED FOR REGULATORY APPROVAL**

Many FEA software packages are unable to address some or all of these issues and have difficulty in converging the large,

## ***Ansys Mechanical makes it easy to calculate forces at any point in the domain.***

ends of the heat exchanger. Baffle plates used to support the tubes are held in position with tie rods that also thermally expand. The model developed included contacts between the tubes and the baffle plates, and contacts between the baffle plates and the external exchanger shell. This idealization provided support to the tubes and permitted differential thermal expansion

complex models required to address them. The manufacturer originally tried simulating the design with software integrated into a computer-aided design system. That software was not well-suited for the complex arrangement with so many contacts. Using Mechanical for pressure vessel and exchanger analysis provides the robustness and reliability needed to solve the large, complex models. Mechanical software contains stress linearization tools that separate stresses through a section into membrane, bending and peak stresses. For a cantilevered plate, the membrane stress results from a tensile load while the bending stress is generated by applying a load normal to the cantilever. Mechanical makes it easy to calculate these stresses at any point in the domain. The software also has advanced fracture mechanics simulation capabilities, which are used by Grantec for fitness of service assessment of pressure and structural components.

Grantec engineers applied Mechanical to assess the heat exchanger based on ASME BPVC Section VIII Division 1 – Part UHX requirements, including the multiple load cases required for

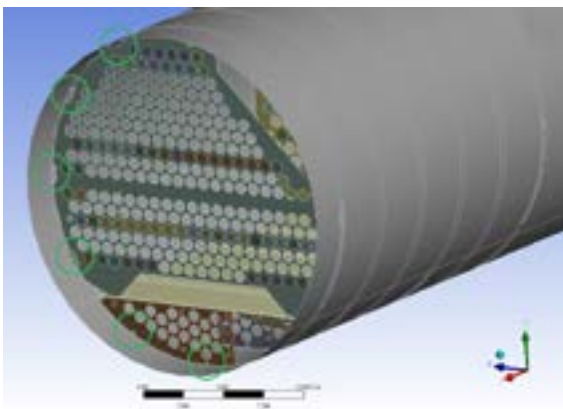

**Connections between tubesheet and shell. The baffle-to-shell welds are circled.**



## The Grantec analysis reports resulted in fast approval of the heat exchanger designs by the regulatory authorities.

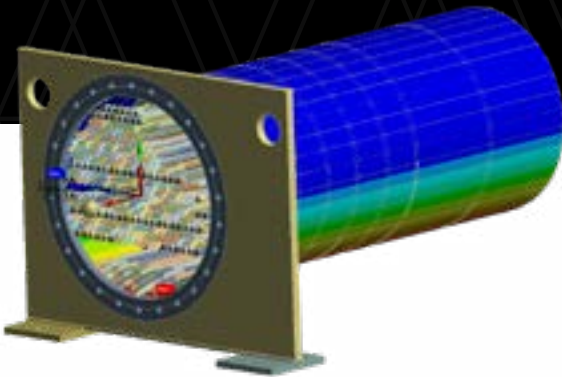

**Hydrostatic pressure in shell**

each exchanger configuration. The models also included the corrosion allowance stipulated by the manufacturer. Engineers used solid elements to model the tubesheet, exchanger supports and welds, and the portion of the tubes in the vicinity of the tubesheet for greater accuracy. To improve computational efficiency, shell elements were employed to model the remainder of the shell and tubes, along with the baffle plates. The properties of the shell elements used for the tubes were modified to reflect the moduli and Poisson's ratio derived from the separate analysis of the finned tubes. Frictionless contacts for the model were used at partition plates so that tube support and thermal growth could be accurately simulated. The Grantec team modeled connections with various contact conditions including bonded, no separation and frictionless. The team applied pressure and thermal loads to the models. The weight of the components and tube fluid was considered using gravity load while engineers accounted for the weight of the shell fluid and static head with a hydrostatic pressure load. Gasket and bolt loads were also included in the models at the end head locations.

### **FAST REGULATORY APPROVAL**

Grantec engineers solved the models using the Ansys High-Performance Computing (HPC) software suite on a 16-core HPC platform. The use of [Ansys HPC](#) proved effective in reducing the analysis run times for the computationally

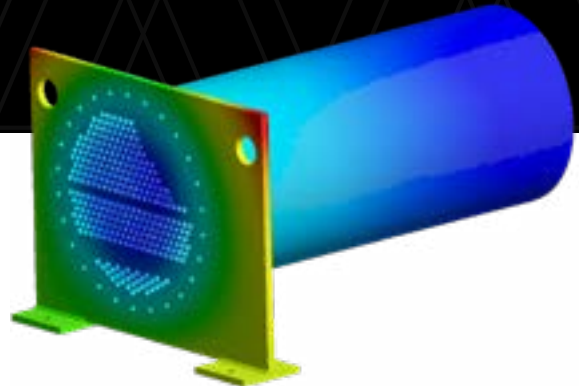

**Deformation simulation using Ansys Mechanical**

demanding analysis, some of which had upward of 500 contacts and thus were highly nonlinear.

In addition to the ASME requirements, the analysis was performed and documented as required by the Canadian Standards Association (CSA) B51-14 Boiler and Pressure Vessel Code, Annex J: Finite Element Analysis Requirements. The Annex J requirements include demonstration and documentation of the validity of the FE analysis results. Among them is the demonstration that stress results have converged. As a result of using the Ansys HPC software, Grantec was able to quickly perform numerous analyses with focused mesh refinement in areas exhibiting high stresses to confirm convergence and the acceptability of the stress levels.

The Grantec analysis reports resulted in fast approval of the heat exchanger designs by the regulatory authorities. During their review, a technical specialist working for the regulatory agency commended Grantec for the thoroughness and completeness of the submission. ▲

### **NOTE**

*Grantec's Richard Grant is a member of the CSA B51 committee and has contributed to the authoring of the Annex J Finite Element Analysis Requirements published in the 2014 and 2019 editions of CSA B51.*

# Savings Boil Over

Gas condensing boilers rely on the successful thermal exchange between hot flue gas and water flowing within the tubes of a heat exchanger. Ferroli, a manufacturer of boilers and renewable energy products, used Ansys Fluent to respond to market requirements for a high-efficiency heat exchanger. The results enabled its engineers to create an optimized design for a robust, high-performance condensing heat generator.

**Stefano Argenton**, R&D Product Development, Ferroli, San Bonifacio, Italy

**G**as boilers are widely used to power domestic and commercial central heating systems. Unlike conventional boiler designs, condensing boiler technology can recover heat loss. Because condensing boilers are more energy efficient and environmentally friendly, some countries mandate their use in new installations.

Ferroli is an Italian manufacturer of heating appliances founded near Verona in 1955. The company has brought many appliances to the global marketplace, including a range of gas condensing boilers. With an innovative design, these boilers offer 100% thermal efficiency — a measure of the ability of the exchanger to transfer heat from the combustion process to the water or steam in the boiler.

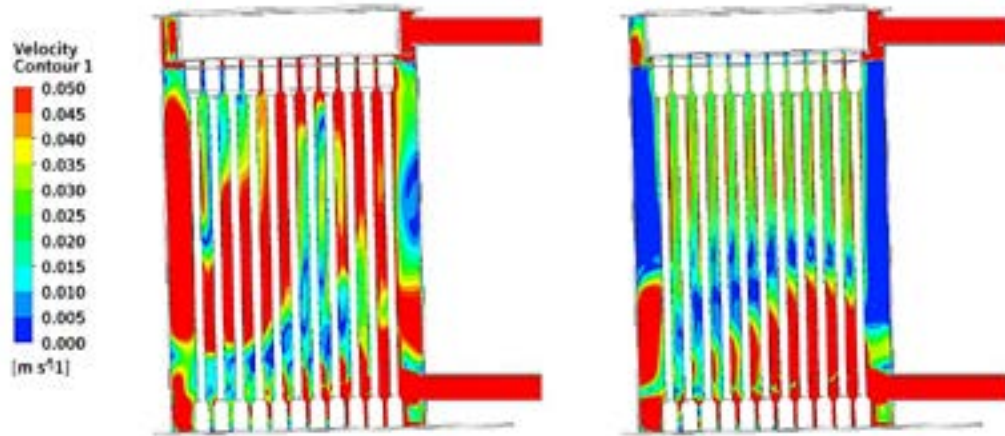

**Velocity profile comparison between the new design (left) and the old design**



After a benchmark analysis, marketing and the research and development director decided a new boiler was needed. One of the main goals was to improve efficiency and robustness. Engineers at Ferroli employed Ansys Fluent computational fluid dynamics (CFD) software to design it. The results of the simulation allowed the engineers to create a good design achieving the requirements of both efficiency and durability of the device.

### INSIDE THE BOILER

As a shell and tube heat exchanger, Ferroli's condensing boiler model consists of a vertical tube arrangement inside a stainless steel shell. It has a power output of 320 kW and is used to heat the central heating system in commercial settings, such as hospitals and shopping malls.

The process starts in the combustion chamber where natural gas is ignited by the burner. Flow through the shell is countercurrent in that the hot flue gas flows in the opposite direction of the water flowing through the tubes. The "feed" water, which is cool from having circulated around the heating system, enters through a pipe at the bottom of the boiler. As it flows up through the heat exchanger, it is reheated. The hot water then leaves through the "supply" pipe at the top of the boiler to continue circulating around the heating system.

As the flue gas is conducted down through the shell from the combustion chamber, its heat is also transferred to the cool feed water. As this flue gas cools, the water vapor contained within it gradually condenses. The condensate is discharged through a waste water pipe. As a result, condensing technology recovers the heat that otherwise would have been lost to the environment via the flue.

Components within the heat exchanger that are vital to a successful thermal transfer between the two fluids are the tubesheet and the baffle. A tubesheet is a plate that is secured at both ends of the heat exchanger. It is welded to the shell and includes holes through which the tubes that contain the flowing water are inserted. Baffles located within the shell are designed to support the tubes and direct flue gas across the tube bundle, allowing for efficient heat transfer.

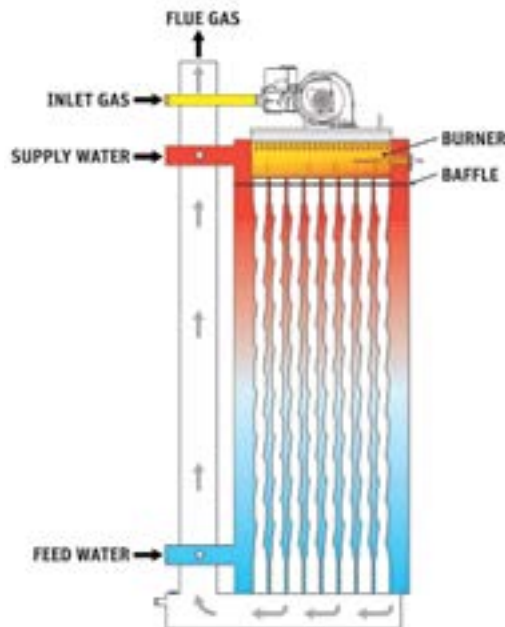

**A working diagram of a boiler shows how heat is exchanged.**

# *Ferrolì immediately saved €75,000 in equipment and labor costs with Ansys Fluent, but the gains of making it to market faster are immeasurable.*

## THE KEY TO DEVICE IMPROVEMENT

When Ferrolì's engineers started the design study of the new boiler, the first concern was the possibility of limescale formation inside the heat exchanger. Limescale is a result of hard water. Depending on where you live in the world, water is characterized as either hard or soft. Hard water contains a significant quantity of dissolved minerals, such as calcium and magnesium, which can settle in the pipework forming a hard, chalky deposit. The accumulation of limescale in the heat exchanger caused water to become trapped and overheat, which raised the temperature of the steel tubesheet.

Ferrolì's engineers employed Ansys Fluent software to analyze the internal water distribution within the heat exchanger. Their goal was to improve the heat exchange coefficient under the tubesheet, leading to higher water flow velocity.

To predict the fluid flow behavior of water as it enters the heat exchanger and its distribution through the tubes, Fluent was used to solve the various equations for flow velocity, flow path and heat transfer. In particular, the engineers used the K-epsilon turbulence model feature to predict turbulent flows.

## STEPS TAKEN TO SOLVE THE PROBLEM

Engineers began by analyzing the previous boiler design as a starting point for the design study of the new one. In addition to the meshed virtual model created with Ansys meshing, a physical boiler model was being tested in Ferrolì's test lab. A comparison was made between the lab test results and the results of the simulation. The simulation model was updated with boundary conditions of heat transfer and heat loss that were discovered as a result of the lab tests.

With the results of the simulation, together with the engineering expertise garnered over many years of designing boilers, the engineering team decided to update the shape of the baffle. An analysis of this new model revealed a substantial improvement in the flow and heat exchanging behavior of the boiler.

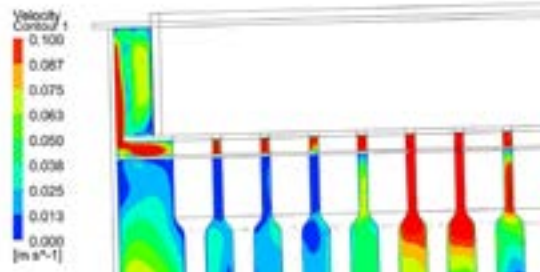

**Velocity profile of the new boiler with the new baffle's shape**

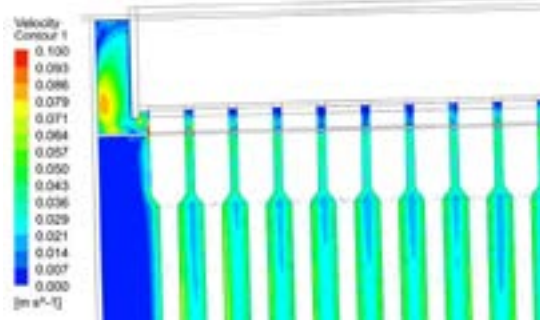

**Velocity profile of the previous boiler baffle design**

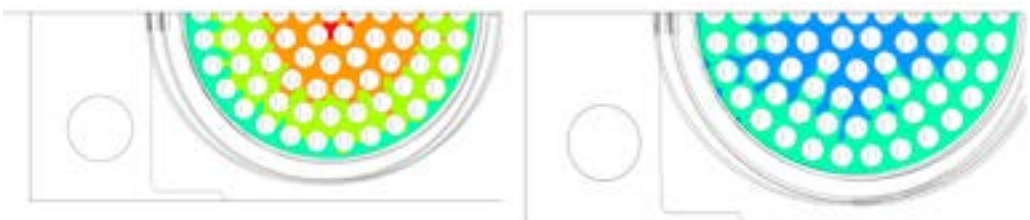

**A simulation of the temperature of the upper plate before (left) and after the redesign**

**Measurement of the combustion chamber temperature with TC2 welded in the central point**

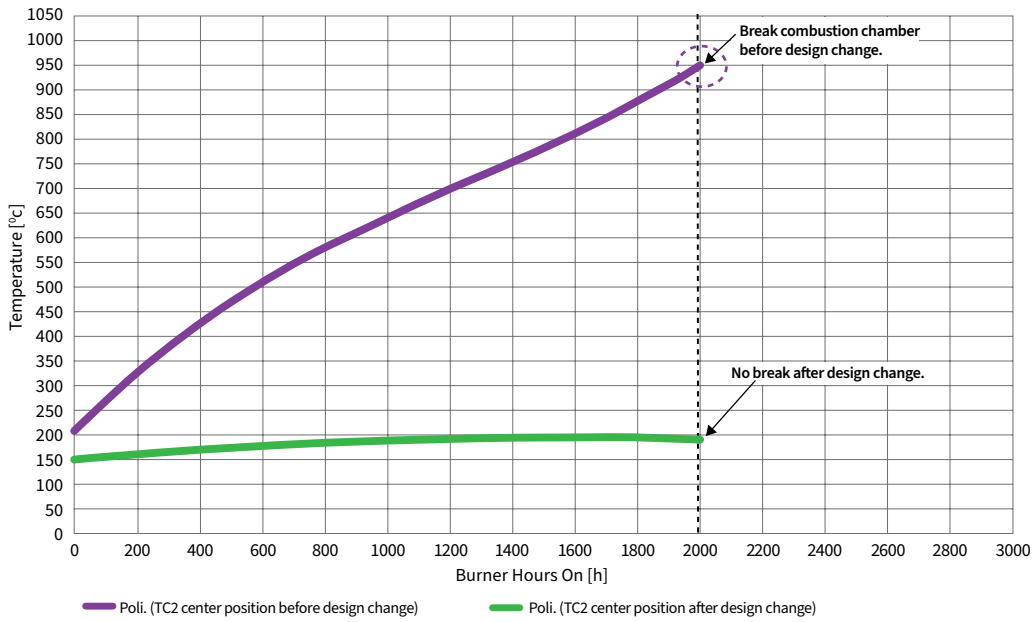

**Test conditions:**  
 - Boilers connected to the direct system with 15°/16° F of water hardness  
 - Operation at maximum power  
 - Cyclic operation: 12h on, 1h off

**Graph of the failure during cycle lab test under extreme working conditions. This condition is rarely encountered during real field operation.**



A further change was made to the design to decrease the space between the tubesheet and baffle and increase the diameter of the baffle’s holes in some areas while decreasing them in others. This change allowed for the best flow distribution and increased the velocity of the water flowing between the tubesheet and baffle. Limescale does not form above a particular water velocity value. Furthermore, higher water velocity under the upper plate lowers the steel temperature, so the working life of this boiler increases.

It took just three simulations to find the right design for the boiler. A prototype of this design was produced and installed in Ferrol’s test lab in August 2018. Following one year of physical testing, the prototype confirmed the results of the Ansys analysis.

**SAVING BOTH TIME AND MONEY**

Previously, four physical prototypes had been built to find the best solution for increasing the efficiency and durability of the boiler. However, with the use of Fluent CFD software, only one physical prototype was needed for the new boiler model. Considering the time it takes to build and then test four prototypes, Ferrol estimates that it has saved at least one year of product design and development time by using simulation. The associated cost in lost opportunities and sales during that year is immeasurable.

In addition to saving valuable time, simulation also yielded substantial equipment and labor savings for the company. One physical prototype costs €20,000 (about \$22,000) to build, so Ferrol immediately saved €60,000 by using simulation on boiler projects. At least two operators would then take five days to prepare the test and analyze the physical test data, which is estimated to cost around €15,000 more.

Given the impressive time and cost savings of the boiler project, Fluent CFD software is now being used in more projects at Ferrol. For instance, it’s being employed in the simulation of new designs, such as heat pumps and biomass combustion products. The use of simulation is also being expanded to solve additional issues and enhance the performance of existing products. ▲



# ***Simulating a Salt-Cooled Reactor for Safety***

By **Fatih Sinan Sarikurt**, CFD & Thermal Fluids Engineer, Kairos Power, Alameda, U.S.A.

The world increasingly relies on electricity, and nuclear energy is a carbon-free source of power. To improve upon existing technology, Kairos Power uses computational fluid dynamics (CFD) and structural simulation solutions to develop the heat transport system for a low-pressure, high-temperature nuclear power reactor.

**A**s demand for power increases, electricity generated from low-carbon sources is playing a strong role in the move toward global electrification. Thermal power plants working with coal and natural gas offer the best opportunity to be upgraded to eliminate or reduce CO<sub>2</sub> and other greenhouse gas emissions. Consumer and industrial companies are seeking to acquire the electricity to power vehicles, and to heat and cool buildings and a wide variety of other systems using small-carbon-footprint sources.

That is where nuclear energy comes in. Currently representing 20% of electricity generation, nuclear power plants are carbon-free. Nuclear reactors do not produce air pollution or carbon dioxide while operating, so they can help reduce the world's carbon footprint. New nuclear reactor technology has the potential to make the impact even larger.

Of the planet's 450 nuclear power reactors, 96% are water-cooled. Most operate at about 315 C and require high pressure to keep the water from vaporizing and losing its heat transfer capacity.

To improve safety, efficiency, sustainability and cost, Kairos Power — which focuses on the integrated design, licensing and demonstration of advanced reactor technology — is developing a unique, fourth-generation advanced nuclear reactor for commercial grid electricity production. The company's low-pressure, high-temperature Kairos Power Fluoride Salt-Cooled High Temperature Reactor (KP-FHR) system mitigates the risks associated with water-cooled technology and has a near-zero carbon footprint.

The KP-FHR leverages tristructural isotropic (TRISO) fuel particles — a uranium kernel with a coating around it — that can withstand temperatures as high as 1,600 C without melting and uses fluoride salt coolant instead of water in its heat exchange process. Because molten salt remains liquid without pressurization between 500 C and 1,400 C, it enables superior heat transfer capability at extreme temperatures. The KP-FHR releases heat into molten salt from spherical fuel pebbles and transfers it to the heat exchanger. The heat exchanger's twisted elliptical tube geometries improve heat transfer with a marginal increase in frictional losses, meaning there is lower heat exchanger volume and reduced operational cost.

Kairos Power uses [Ansys Fluent](#) to characterize the design for

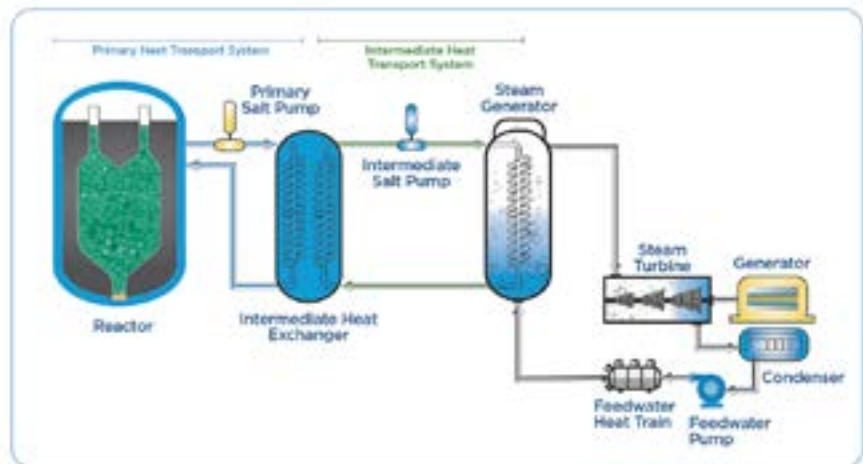

**Ansys Fluent enabled the design of the KP-FHR intermediate heat exchanger's twisted tubes and provided insight into the design of the reactor core.**



**The packed pebble reactor core leverages TRISO fuel particles.**

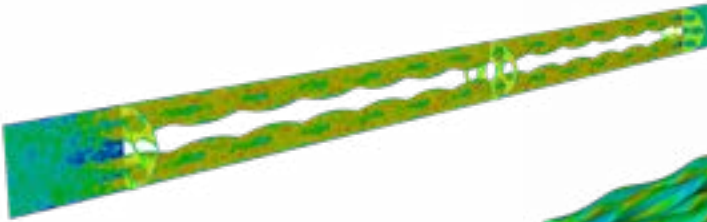

**Ansys Fluent simulation showing instantaneous flow velocity**

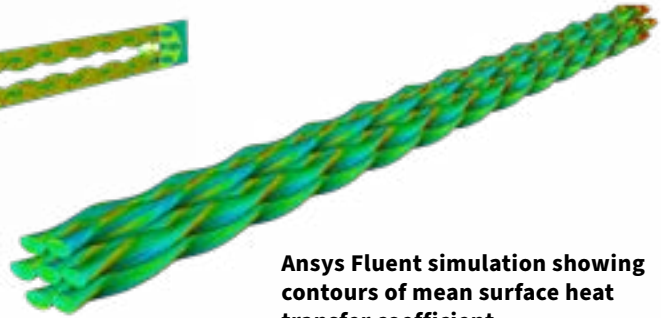

**Ansys Fluent simulation showing contours of mean surface heat transfer coefficient**



the KP-FHR intermediate heat exchanger. Through simulation, Kairos Power reduced the number of design iterations, lowered costs compared to physical testing and shortened the overall development time.

The company adopted Ansys technology for informing the design of both safety- and non-safety-related systems, because Ansys is committed to the development of software tools, including Fluent and [Ansys Mechanical](#), that follow the ASME's Nuclear Quality Assurance-1 (NQA-1) requirements as endorsed by the U.S. Nuclear Regulatory Commission (NRC).

**POROUS MEDIA MODELING FOR DIFFICULT CALCULATIONS**

Analyzing flow and heat transfer characteristics in a system like the KP-FHR, where molten salt flows through a random-packed pebble-bed reactor core, is difficult. Among other Fluent features, engineers used porous media modeling in initial design iterations for the reactor core, including calculating temperature distribution.

Because of the huge number of pebbles in the core, modeling flow and temperature fields any other way would require an enormous number of calculation cells and unfeasible computational power. By using the porous media modeling capabilities in Fluent, engineers created a local equilibrium model of the full reactor vessel with a reasonable number of mesh cells. As a result, they were able to calculate the temperatures of fuel, molten salt and internal structures at various locations in the reactor core.

**SIMULATING PRESSURE DROP, HEAT TRANSFER COEFFICIENTS**

To inform the reduced order modeling of the KP-FHR reactor system, engineers were particularly interested in analyzing pressure drop and heat transfer coefficient values in the explicit packed pebble-bed core.

Often, correlations from previous experiments can be used, especially when Reynolds number ranges are similar. In this case, however, heat transfer correlations from gas-cooled reactors could not be used because of the distinct properties of the molten salt, which has high Prandtl numbers. Instead, simulation provided a way for Kairos Power engineers to arrive at the information they needed faster to satisfy the demanding timeline of the agile design process.

**ONE DESIGN INFLUENCES THE OTHERS**

With a design this complicated and so much at stake, Kairos Power also needed a reliable way to test the twisted elliptical tube.

Using Mosaic-enabled meshing technology in Ansys Fluent, engineers created a mesh of a twisted tube bundle and then compared the results against experimental correlations. The parallel meshing process produced a high-quality mesh eight times faster



**A twisted tube heat exchanger provides better heat transfer and costs less to operate.**



**Nuclear Power**  
[ansys.com/nuclear](https://www.ansys.com/nuclear)



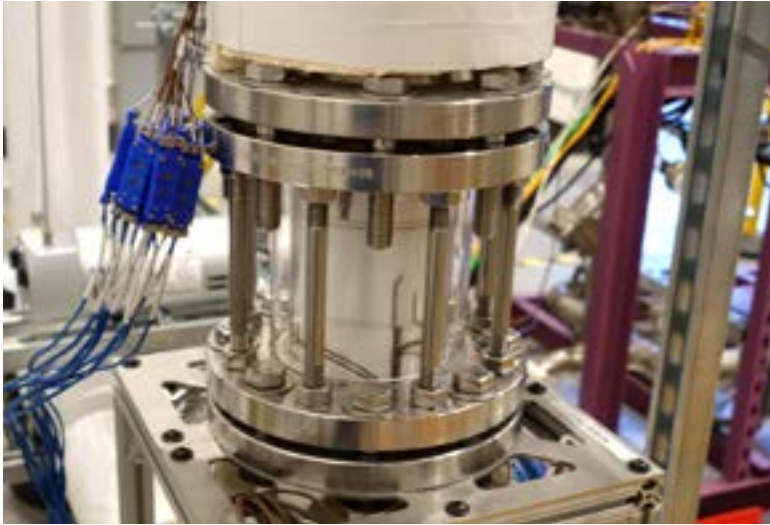

Through simulation, Kairos Power reduced the number of design iterations, lowered costs compared to physical testing and shortened the overall development time.

***Kairos engineers' ability to gather data via experiments is limited, but with Ansys simulations they can extract detailed, spatially resolved data to better understand local conditions.***

and with less user input compared to other meshing software Kairos Power engineers had used before.

The pressure drop values derived from the Fluent twisted elliptical tube simulations did not just affect the twisted elliptical tube design; they also drove design requirements for other components, including the pump. In addition, by identifying hot and cold spots in the reactor core, the simulation enabled engineers to improve the integrity of structural materials. Finally, Fluent's scaling capabilities allowed Kairos Power to conduct rapid iterative testing on smaller-scale geometries, accelerating design evaluations while optimizing the research budget.

#### **FASTER DESIGN, FASTER EVALUATION**

The high temperature range of the KP-FHR promises efficiencies; however, it also creates design challenges. Kairos has a design strategy that emphasizes rapid iteration in scaled testing using prototypical and surrogate fluids. Ansys enables the company to accelerate design and understand scaling distortions in our rapid design/build/test iterations, and to extract additional understanding. Kairos engineers' ability to gather data via experiments is limited, but with Ansys simulations they can extract detailed, spatially resolved data to better understand local conditions.

Ultimately, Fluent and Mechanical helped engineers understand:

- Effects of geometry and flow conditions on the twisted elliptical tube design
- Hot/cold spots throughout the domain
- Thermal stratification
- Scale-up behavior as the number of twisted elliptical tube bundles increases
- How to model a plant-scale heat exchanger

Kairos Power's rapid iteration between design, modeling and testing improved risk management capabilities and enabled early identification of high-risk issues.

Although the KP-FHR has not yet reached the commercialization stage, Ansys simulation software accelerated design evaluations, enabled rapid iteration in testing, and helped mitigate technology development risk. ▲

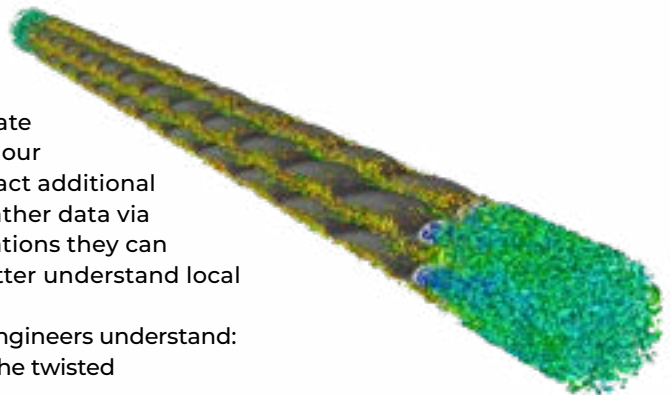

**Ansys Fluent transient simulation showing contours of velocity magnitude for the twisted tube**

# *Fast Fluid Simulation on the Cloud*

By Ansys Advantage Staff

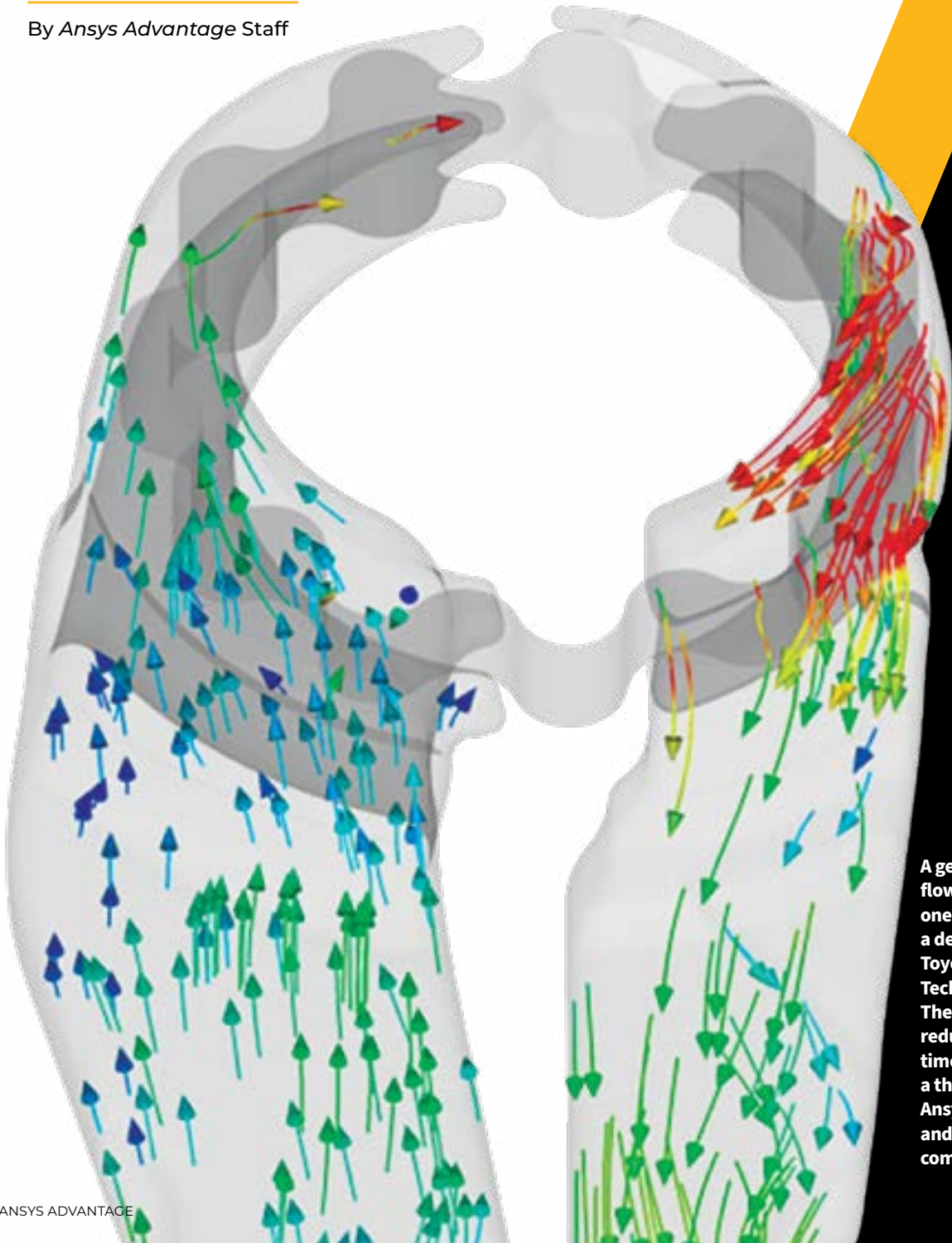

A gear pump flow diagram is one example of a design from Toyo Advanced Technologies. The company reduced analysis time by about a third by using Ansys Fluent and cloud computing.

**M**AZDA MOTOR CORPORATION develops vehicles efficiently by incorporating model-based computer-aided engineering (CAE). Toyo Advanced Technologies, a spinoff of Mazda, engineers, manufactures and supplies oil pumps for automatic transmissions mounted in automobiles equipped with Mazda's SKYACTIV technologies, which increase fuel efficiency and engine output. The company also produces fuel rails, which transfer fuel to each cylinder of an engine. To survive in the auto parts industry, where competition is heating up globally, a high-performance product must be developed quickly to meet clients' schedules and requirements. To perform analyses rapidly and affordably, Toyo Advanced Technologies engineers used [Ansys Fluent](#) via a cloud service for model-based CAE, instead of installing a high-performance computing (HPC) system in their own facility.

**SIMULATION IS KEY**

"There is no doubt that CAE is necessary," says Mitsunobu Matsuda, manager of the Automotive Components Engineering Department of Toyo Advanced Technologies, which includes sales, design, testing and production technology. "Without CAE, we are unable to meet fast-growing demands from clients."

In the case of an oil pump, technical requirements such as discharge volume and size are submitted by a client. Engineers estimate the part shape and size based on the technical requirements to achieve the client's goals. According to Matsuda, engineers are not good at such goal-oriented estimation if a synergistic effect or interaction is involved.

"What engineers are good at is making a pump with a shape temporarily determined by simple calculations, testing it and then repeating the steps based on the results until the client's specifications are met," Matsuda says. "This process is very easy but does not satisfy the client. Only one correct, goal-oriented estimation leads to the best solution. CAE can perform this estimation instead of engineers. This is one of the benefits of CAE."

As an example of a synergistic effect or interaction, Tetsuya Okimoto from Toyo's Automotive Components Development Division cites hydraulic pressure. "The pulsation of hydraulic pressure generated by the pump depends on hydrodynamics, with factors such as the pump specifications, the shape of the hydraulic pressure supply destination and the volume," he says. However, because pulsation includes the interaction of these different variables, the calculation formula is complicated. "Therefore, the only means for calculating this pulsation is CAE," Okimoto says. "We succeeded in calculating this using Ansys Fluent."

**KEEPING PACE WITH CLIENTS**

Toyo Advanced Technologies decided to use CAE for single-phase fluid flow and multiphase flow with cavitation in 2012 to decrease development time. In the summer of 2017, the company introduced Fluent to further improve the efficiency of pump development. The Automotive Components Engineering Department replaced its conventional

analysis tool with Fluent to take advantage of its high-accuracy pump analysis models and the company's highly acclaimed technical support. "We read another company's report on a pump that said an Ansys development tool was used, so we contacted Ansys for benchmarking," says Okimoto. "Actual data was so closely replicated by simulation in the benchmark test, and Ansys' technical support service level was so high, that we decided to implement the software."

Analysis Model	Computing Time	
	Internal PC	Cloud HPC
Gear pump unsteady analysis	2 days	0.7 days
Vane pump unsteady analysis	3 days	1 day

**Computing time comparison before and after cloud HPC implementation**

**CLOUD SPEEDS ANALYSIS, REDUCES COST**  
Toyo Advanced Technologies ran Fluent on an internal PC for a while after implementation.



**Cloud Computing for Engineering Simulation**  
[ansys.com/cloud-computing](https://ansys.com/cloud-computing)

## ANSYS CLOUD CONVENIENCE

Ansys customers like Toyo Advanced Technologies have several options to incorporate high-performance computing into their simulation workflows. One convenient option is Ansys Cloud.

Ansys Cloud makes it seamless, easy and cost-effective to harness the full power of Ansys simulation software on an as-needed basis — enabling fast, flexible access to the processing capabilities needed to run large simulations or multiple, full-featured simulations faster. Ansys has partnered with Microsoft to provide access to the Microsoft Azure cloud computing platform from within Ansys applications.

No cloud environment configuration is needed because Ansys Cloud is optimized for Ansys software, and hardware configurations are preconfigured. Ansys Elastic Units (AEUs) can be used on-premise and on the cloud, allowing customers the flexibility to make the most of their hardware and software resources.

The Azure platform follows Microsoft’s security best practices, which include third-party auditing. Users can easily monitor the progress of their simulation from within the Ansys application, or from a web-based cloud portal.

If you’d like to try Ansys Cloud for free, visit [ansys.com/freecloudtrial](https://www.ansys.com/freecloudtrial).

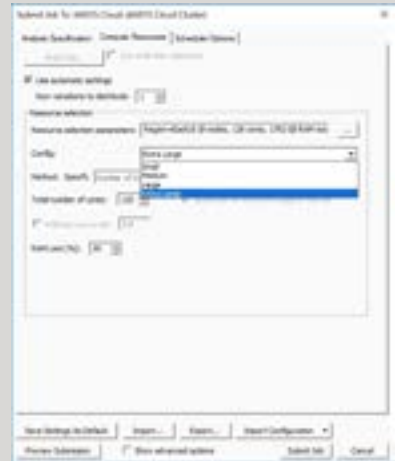

Though they were satisfied with the analysis accuracy of Ansys Fluent, a pump fluid analysis sometimes took three days, even on a computer with 24 cores.

“It is not just about the accuracy of computing results. Who wants to use software that takes three days to process?” asks Matsuda. “So, we searched for a solution to this problem and found a cloud service.”

The company could have built an HPC server internally to speed up analysis, but that would have required a substantial initial investment as well as continued investments in operation and management. Considering the company’s size and software use frequency, they decided to use a cloud service. Another deciding factor was that letting a cloud service manage the hardware enabled engineers to concentrate on analysis tasks instead of system operation and maintenance.

The company started using Rescale Japan’s cloud HPC service in early 2018 to increase its analysis speed.

After confirming that Fluent would work on this service, it took about two weeks from when the budget for service implementation was approved to when the service became available. Toyo Advanced Technologies started using 128 cores via

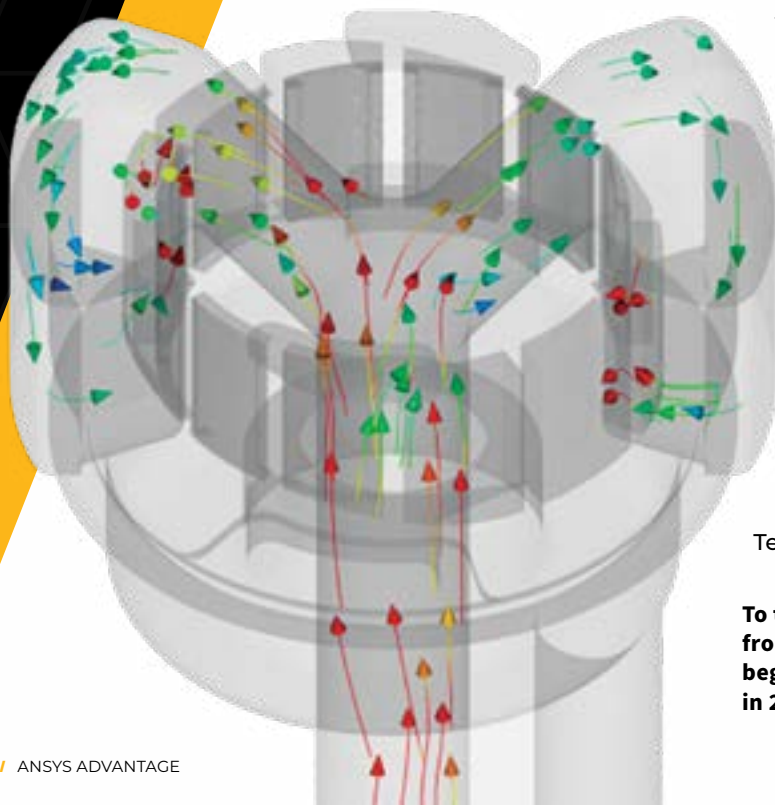

**To the left is a vane pump flow diagram from Toyo Advanced Technologies, which began using computer-aided engineering in 2012 and Ansys Fluent in 2017.**

*“There is no doubt that CAE is necessary. Without CAE, we are unable to meet fast-growing demands from clients.”*

— Mitsunobu Matsuda, Toyo Advanced Technologies

Rescale Japan, as well as its internal PC with 24 cores. This successfully reduced the analysis time by 66% — from three days to one. It takes 30–60 minutes to download analysis results, but using a cloud service is far more cost-effective than installing an HPC server internally.

#### REDUCING DEVELOPMENT TIME AND PROTOTYPES

The Automotive Components Engineering Department’s goal is to develop a pump that satisfies their client’s requirements within three months. Ideally, that includes three weeks of concept design for a rough structure, two weeks of detailed design for the actual part shape and size, about a month for prototyping, and two or three weeks confirming that the prototype meets the requirements. However, it used to take six to seven weeks just for concept design, which caused a bottleneck. Running Fluent on a cloud HPC service successfully reduced the concept design time to fit into its three-week window.

Fluent simulations also reduced the number of prototypes created at each development stage. In the parts development stage of pump design, Toyo Advanced Technologies reduced both the number of prototypes and costs by up to one-third using simulation. In the light of such results, employees now say: “Why make prototypes? We have CAE.”

Matsuda is thinking about further improving the analysis accuracy so that Ansys Fluent can be used for new product development. This would involve determining the direction of a basic pump structure in the concept design phase and optimizing its shape. Then, in the detailed design phase, he would like to estimate the performance of an optimized shape.

“We would like to be a supplier who gives the first priority to solving client problems,” says Matsuda. “The happiest thing as an engineer is being the first one called on by clients whenever they have problems.” ▲

#### MORE THAN 90 YEARS OF HISTORY

The history of Toyo Advanced Technologies dates back to 1929, when the company began producing grinding machines as a department of Mazda Motor Corporation (then Toyo Kogyo Company Limited). Dealing in machine tools and automotive components, the company spun off from Mazda Motor Corporation in 1989 to become Toyo Advanced Technologies Company Limited. Their main business is in machine tools, specifically internal grinding machines, for which they have the leading market share in Japan. They also have a metal coating business, which offers special coatings for molds and tools, and an automotive components business, which develops, manufactures and sells automatic transmission unit oil pumps and fuel rails for fuel supply equipment.

**SALES:** 24 billion yen, about \$220 million (fiscal year ended March 2018)

**PAID-IN CAPITAL:** 3 billion yen, about \$25.5 million (as of March 2018)

**NUMBER OF EMPLOYEES:** 625 (as of March 2018)



# ANSYS Hall of Fame Winners

Baseball players have Cooperstown, rock-and-roll stars have Cleveland and — for the last 11 years — engineers have had the annual Ansys Hall of Fame competition. The contest showcases how engineers are using Ansys simulation solutions.

The Hall of Fame grew significantly in 2020, with a 21% increase in total submissions compared to 2019. The submissions, which were sent from nearly 20 countries, were divided into corporate and academic categories. Corporate winners included companies that used simulation to lower costs, reduce emissions, prevent damage and save time in fields as varied as asphalt equipment, electromagnetics and turbomachinery. Academic winners used simulation to detect unexploded landmines, and better understand actual and artificial hearts.

## CORPORATE WINNERS

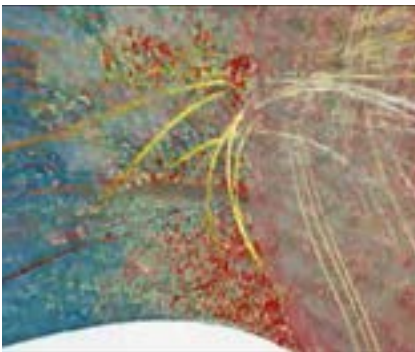

**ASTEC, INC.** engineers identified an opportunity to optimize an asphalt drying process in which the phase change of liquid to gas can consume half the energy input. By developing software to capture the mass transfer between aggregate particles and using Ansys to solve exchanges between the fluid phase, the team designed a more efficient dryer that lowers running costs and reduces emissions.

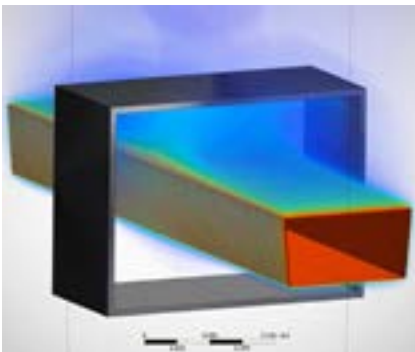

**DRUIDS PROCESS TECHNOLOGY S.L.** developed an electromagnetic detector to sense internal cavities that can block production in high-temperature copper. Engineers used Ansys solutions to check the coil configuration and induce currents, monitor the detector's behavior at extreme heat, and determine whether thermal and pressure effects could damage the coil shield.

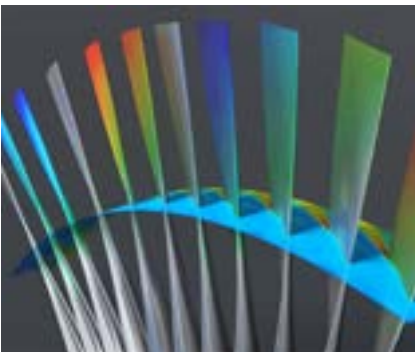

**NUM** solution created its own flutter tool for automatic blade flutter prediction with Ansys simulations, leading to a 60% reduction in simulation time and a 95% reduction in pre- and post-processing time. The solution is being used to accelerate the development of a flutter-free blade, which will reduce blade loss and damage in large-scale turbomachinery.

## ACADEMIC WINNERS

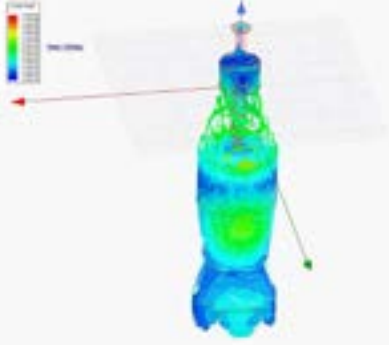

**King Abdullah University of Science and Technology** used Ansys to detect unexploded landmines — a massive problem in some countries — that cannot be detected with conventional radar. Researchers obtained the radar cross section of a 330-milliliter plastic bottle filled with dielectric materials to mimic explosives and applied machine learning techniques for better landmine detection.

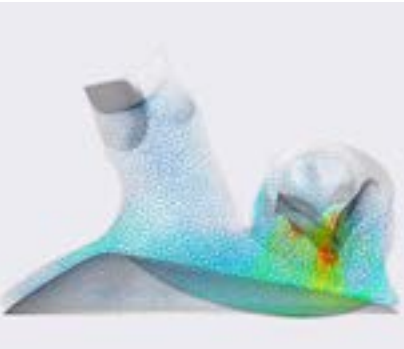

**Politecnico di Milano** simulated an artificial ventricle to develop a computational model that accurately reproduces the hemodynamics inside the left chamber of an artificial heart. The results from fluid–structure interaction simulations led to realistic kinematics of the valve leaflets and membrane.

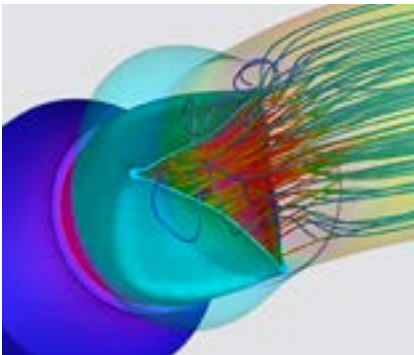

**University of Rome Tor Vergata engineers** used Ansys solutions to perform cardiovascular simulation with moving walls and applied it to the fluid–structure interaction analysis of a custom valve coupled with patient data. They developed a high-fidelity, fast and accurate way to bring simulation into the clinic.

View the Ansys Hall of Fame Archive at [ansys.com/other/hall-of-fame/archive](https://ansys.com/other/hall-of-fame/archive) for submissions from previous years' competitions.

# Simulation in the News



## Ansys 2020 R1 Digitally Threads Simulation Across Product Lifecycle Processes

January 2020

Companies are accelerating digital transformation by integrating cutting-edge Ansys technology across product lifecycle processes through new functionalities released in Ansys 2020 R1. From improving product development with Ansys Minerva to running complex simulations with substantially streamlined workflows with Ansys Fluent to optimizing electromagnetic design processes with Ansys HFSS, Ansys 2020 R1 enables companies innovations and create cost-effective designs.

As simulation impacts virtually every product decision, users must address considerable scale and of interoperability, data and process management, high (HPC) integration, and traceability. Additionally, sophisticated and optimization assets must be widely available through lifecycles. Ansys 2020 R1 addresses this with portfolio-wide — enabling customers to connect simulation and optimization.

Minerva now incorporates technologies for significant simulation process and data management (SPDM). This includes dashboards that drive improved decision support, dynamic 3D visualization tools for exploring model data, and a system for managing change and ensuring reliability of information. For example, OptiSlang — a technology now owned by Ansys as a result of the recent acquisition of Dynardo — teams with Minerva's SPDM solutions to help users reduce development time and expedite the evaluation of affordable optimal design alternatives.

Ansys 2020 R1 also delivers upgrades across the portfolio, including structures, fluids, 3D design, electromagnetics, additive manufacturing, materials, optics, cloud computing, semiconductors, systems and embedded software.

Learn more: [ansys.com/products/release-highlights](https://ansys.com/products/release-highlights)

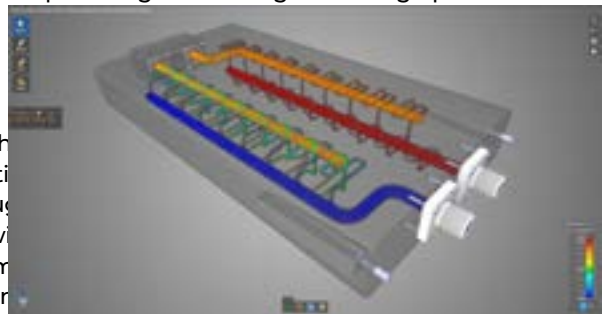

## Rockwell Automation and Ansys Announce Partnership

*Modern Materials Handling, November 2019*

Industrial companies now have access to a streamlined, holistic, end-to-end solution for design, automation, production and lifecycle management, thanks to a new strategic partnership between Rockwell Automation and Ansys. The partnership between Rockwell Automation, the world's largest company dedicated exclusively to industrial automation and information, and Ansys, the industry leader in simulation software, was announced at Rockwell Automation's 28th annual Automation Fair in Chicago.

Ansys and Rockwell Automation will help customers design simulation-based digital twins of products, processes or manufacturing. Historically, manufacturers would dedicate a significant amount of time and money to develop and test physical product prototypes to arrive at the optimal design. Now customers can design and test through simulation to accelerate development and analysis, improving product quality and reducing testing time (and costs) across their organizations.



# Future Mobility Solutions Showcased at CES

January 2020

Ansys showcased simulation solutions that are accelerating the coming mobility revolution during CES 2020. The Ansys booth featured offerings that are shaping the transformation of connected, autonomous, shared and electric transportation. Attendees visiting the Ansys booth could see the record-shattering Volkswagen Motorsport I.D. R electric race car along with autonomous, electrified and connected robots; an interactive kinetic display; interactive touchscreen demo stations; and more.

Beyond the booth, Ansys' Mobility Tour provided attendees with interactive glimpses into the ongoing collaborations that are shaping emerging innovations in autonomy, 5G and electrification. Check out some of the highlights from the Ansys booth and Mobility Tour below.

- **BMW:** Insight into Ansys' and BMW's collaboration involving [Ansys Autonomy](#)
- **FLIR Systems:** Demonstration of Ansys Autonomy with a physics-based thermal camera model for validation of automotive systems
- **Edge Case Research:** Demonstration of [Ansys SCADE Vision powered by Hologram](#) for edge case detection in AV perception systems
- **NXP Semiconductors:** Live demonstration of Ansys Autonomy running on the NXP BlueBox for simulating virtual miles driven, and high-fidelity physics closed-loop, open-loop, and SiL and HiL simulations
- **BlackBerry Limited (QNX):** Demonstration of a lane departure warning system that featured the digital safety workflow provided to validate the advanced driver assistance systems features in closed-loop simulation
- **AEye:** Demonstration of AEye iDAR technology using the [VRXPERIENCE](#) and [SPEOS](#) elements of Ansys Autonomy that showcased hazard detection in a virtual world
- **Embotech:** Motion planning demonstration combined GPS information with sensor information for predictive path planning

## Porsche Fully Electric Race Car Targets Formula E Championship Using Ansys Technology

November 2019

The TAG Heuer Porsche Formula E Team is racing to the finish line of the 2019/2020 ABB FIA Formula E Championship through a new collaboration with Ansys. Porsche Motorsport engineers are using Ansys' industry-leading system-level simulation solutions to create an advanced electric powertrain that will substantially increase energy efficiency for Porsche's first-ever fully electric race car — the Porsche 99X Electric.

Accelerating at extreme speeds through demanding urban courses within metropolitan city centers exerts massive stresses on the powertrain of the Porsche 99X Electric. While regulations stipulate a standardized chassis and battery, engineers can customize the powertrain and its subsystems and components to deliver maximum energy efficiency and vehicle performance from the starting line to the finish line.

Ansys system-level solutions deliver a critical competitive edge for the Porsche 99X Electric, enabling Porsche engineers to create the next-generation Porsche E-Performance Powertrain. This helps provide the highest level of energy efficiency for its vital subsystems and components — maximizing the efficiency of the motor and the power electronics to significantly reduce losses.





## Carnegie Mellon University and Ansys Transform Engineering Education

*Carnegie Mellon University, October 2019*

With the opening of Ansys Hall, Carnegie Mellon University (CMU) and Ansys are expanding their partnership to transform the future of engineering and research by enabling budding engineers to usher in the next industrial revolution. The shared goal is to build groundbreaking approaches and tools that will result in shorter product development cycles and better-quality final products.

The rapid transformation of manufacturing and product innovation is underway, and engineers are using simulation to increase innovation, lower cycle times and increase quality with unprecedented speed. Ansys Hall is a collaborative and hands-on maker facility and education space where students have access to Ansys' leading physics-based simulation tools and cutting-edge technologies for making, assembling and testing their designs.

### Ansys Joins the NASDAQ-100 Index

*NASDAQ.com, December 2019*

Ansys has become a component of the NASDAQ-100 Index. The NASDAQ-100 index is composed of the 100 largest non-financial company stocks listed on the Nasdaq Stock Market based on market capitalization.

"We are honored to join this elite group of the world's most successful and dynamic companies on the NASDAQ-100 Index," said Ajei Gopal, Ansys president and CEO. "The simulation market has incredible growth opportunities, and Ansys' world-class ecosystem and innovative solutions ensure that we are in the best possible position to take advantage of them. This important milestone is a testament to the strength of our Pervasive Simulation strategy."

### Aras Licenses Platform to Ansys in Strategic OEM Deal

*Digital Engineering, January 2020*

Aras has announced a strategic partnership with Ansys that includes the licensing of the Aras platform technology to enable the next generation of digital engineering practices, the companies report.

Ansys will leverage underlying Aras platform technologies such as configuration management, product data management/product lifecycle management interoperability, and application program interface integration. Ansys will add simulation-specific capabilities to deliver scalable and configurable products that connect simulation and optimization to the business of engineering.

## Cloud Computing Growth

### **Ansyes, Azure Pair Up for Digital Twin Cloud Offering**

*HPC Wire, December 2019*

Ansyes, with its *Twin Builder* software, has teamed with Microsoft and its Azure public cloud Digital Twins Platform on a joint product strategy to take on the rapidly emerging digital twins market, which Gartner last year called a top 10 technology trend for 2019. The Ansyes–Azure offering lets users compile simulations into runtime modules that can execute in a Docker container and be integrated automatically into IoT processing systems.

### **Dollars and Sense: Your Next Simulation Should Be on the Cloud**

*Engineering.com, December 2019*

Your CAD/CAE software is not doing you any favors by providing a million-element model that your workstation cannot handle. Engineers have to spend time “defeaturing” the finite element model so that this doesn’t happen. Or do they? HPC (high-performance computing) may provide an alternative to defeaturing.

Ansyes offers two ways to use HPC on the cloud if you don’t want to buy your own hardware. From within several core Ansyes applications, you pick Ansyes’ own HPC service, the *Ansyes Cloud*, on which to run the solution. The Ansyes user can select small, medium, large and extra-large cloud-based server configurations that correspond to 8, 16, 32 and 128 cores, respectively.

Or, users can pick one of more than 10 Ansyes cloud hosting partners. Ansyes has qualified the partners, who have developed their own simulation environment that is compliant with the Ansyes platform.

### **Using Cloud Computing for Engineering Simulation**

*Automotive Testing Technology International, December 2019*

Peerless Research Group conducted a cloud-enabled simulation study for Ansyes and discovered that 37% of respondents are either using the cloud for engineering simulation or are planning to use it in 2020. The benefits cited included the ability to scale quickly and reduce costs. However, according to the survey, the top three engineering benefits are increasing the speed of product development, improving engineering productivity and accelerating innovation.

### **Cloud-Based Engineering Is Poised for Takeoff**

*The Next Platform, December 2019*

The benefits of the cloud’s pay-as-you-go model is drawing in more high-performance computing users with each passing year. One segment that has been somewhat underrepresented is engineering, which increasingly relies on HPC-powered digital simulations for product design and development. A recent survey of engineers conducted by Peerless Research Group, on behalf of *Digital Engineering* magazine and Ansyes, suggests that cloud computing is poised for more rapid adoption.

For those already using the cloud on these workloads, 63% were using an on-premise private cloud, which, depending on how respondents interpreted that category, may be nothing more than a shared in-house cluster. The remainder were split almost evenly between those using the public cloud (35%) and those using an ISV-managed SaaS solution, like the Ansyes Cloud (32%).

## **Telma Shortens Path to Market for Frictionless Braking Systems with Ansyes**

Telma used Ansyes for three new series of retarders — braking systems that use electromagnetic induction — to decrease the number of prototypes required for validation from 10 to one over the course of a decade and reduced fine-particle emissions associated with braking systems by up to 90% while significantly reducing maintenance costs.

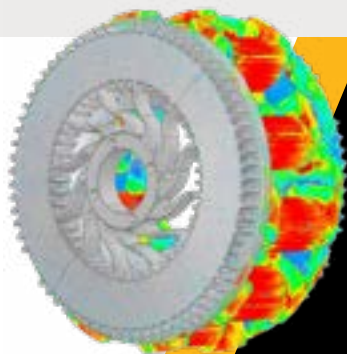

Pervasive Engineering Simulation Means  
**ROAD WORRIER NO MORE**



You've got a lot riding on – and in – your autonomous vehicle. Safety is paramount and speed to market is critical. Only Ansys can deliver a complete simulation solution for designing, testing and validating your autonomous vehicle.

